

WT-Series

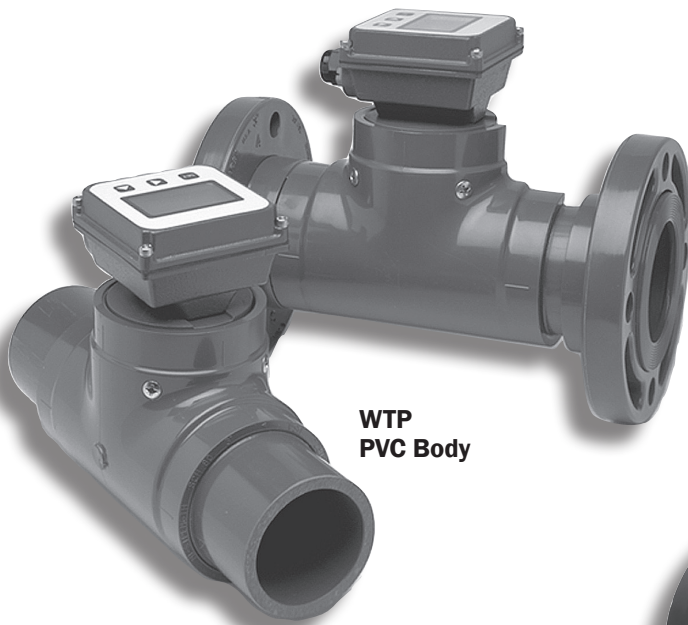

INLINE TURBINE METER INSTRUCTIONS



WTP
PVC Body



WTC
Carbon Steel

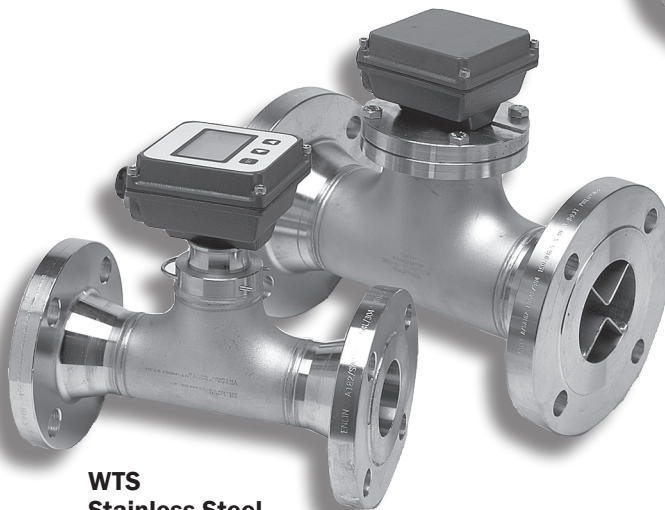

WTS
Stainless Steel

WT-SERIES INLINE TURBINE METER INSTRUCTIONS

GENERAL INFORMATION and SPECIFICATIONS

GENERAL INFORMATION

This unique system of 2" to 8" turbine meters uses just one moving part, a precision helical rotor. Rotation of the rotor is electronically detected and processed. The high-quality jewel bearings and shafts minimize friction while providing long wear life in non-lubricating fluids. The entire rotor assembly can be easily removed for field service without removing the meter from the pipe.

WTP bodies are fabricated from Schedule 80 PVC fittings, WTC bodies from carbon steel tubing, and WTS bodies from stainless steel tubing. The turbine insert on WTC and WTS meters is machined from a stainless steel casting. The WTP turbine insert is machined from a solid piece of PVC. Turbine rotors on all models are Kynar (PVDF).

WT meters can be ordered with various output options. The basic model (100) comes with pulse output only. An electronic display (Seametrics FT420) is mounted on the 101 model to display flow rate and total (resettable or non-resettable), and provide a programmable pulse or 4-20 mA output. Other electronics options include a blind 4-20 mA transmitter (A055) on the 102 model and a battery-powered (FT415) rate/totalizer plus pulse output for applications that lack power (104 model). All of these controls/displays can be mounted on the meter or remotely mounted on a wall or panel up to 2,000 feet away. WT-Series meters are compatible for use with most other remote-mount Seametrics displays and controls as well.

SPECIFICATIONS*

	WTP					WTC					WTS					
Pipe Sizes	2", 3", 4", 6"					2", 3", 4", 6", 8"					2", 3", 4", 6", 8"					
Materials	Meter Body	PVC Schedule 80 fittings					Painted carbon steel					304 Stainless steel (316 SS optional)				
	Turbine Insert	PVC					CF8M cast stainless					CF8M cast stainless				
	Rotor	Kynar (PVDF)					Kynar (PVDF)					Kynar (PVDF)				
	Shaft	Zirconia ceramic 3"-6"					Zirconia ceramic 3"-8"					Zirconia ceramic 3"-8"				
	Shaft	Tungsten Carbide 2"					Tungsten Carbide 2"					Tungsten Carbide 2"				
	Bearings	Sapphire journal, ruby endstone					Sapphire journal, ruby endstone					Sapphire journal, ruby endstone				
Cable	#22 AWG 3-con, 18'; 2000' max					#22 AWG 3-con, 18'; 2000' max					#22 AWG 3-con, 18'; 2000' max					
Flanges	Optional (See Dimensions)					150 lb. drilling (3-8" only)					150 lb. drilling (3-8" only)					
Maximum Pressure	150 psi @ 75° F (10 bar @ 24° C) (see chart)					200 psi (14 bar)					200 psi (14 bar)					
Maximum Temperature	120° F (50° C) (see chart)					200° F (93° C)					200° F (93° C)					
Accuracy	+/- 1% of full scale					+/- 1% of full scale					+/- 1% of full scale					
Flow Range (GPM)	2"	3"	4"	6"		2"	3"	4"	6"	8"	2"	3"	4"	6"	8"	
	Minimum	2	3	6	12	2	3	6	12	30	2	3	6	12	30	
	Maximum	150	400	600	1200	150	400	600	1200	3000	150	400	600	1200	3000	

Electronic Options Specifications*

WT100 (Pulse Output Only)		WT102 (Blind 4-20 Transmitter) (e.g. A055)	
Power	6-24 Vdc	Power	24 - 36 Vdc (isolated)
Pulse Output	0-160 pulse/second current sinking	Analog Output	4-20 mA loop
Regulatory	CE Mark	Response Time	2-60 seconds, 90% of full scale (depends on input averaging)
WT101 (Powered Rate/Totalizer) (e.g. FT420)		WT104 (Battery-powered Rate/Totalizer) (e.g. FT415)	
Power	12-32 Vdc (for 4 mA DC min); 24-32 Vdc (for accuracy of 4-20 mA loop)	Power	3.6 Vdc Lithium battery replaceable, 3-5 year life
Rate	6-digit autorange	Rate	6-digit auto range
Total	8-digit	Total	8-digit
Memory	Non-volatile (no battery needed)	Pulse Output	0.1 second open collector (scaled); 0-75 pulse/second passthrough (unscaled); High alarm or low alarm
Pulse Output	0.1 second open collector (scaled); 0-75 pulse/second passthrough (unscaled); High alarm or low alarm		
Analog Output	4-20 mA loop (24-32 Vdc required)		
Regulatory	CE Mark		

*Specifications subject to change • Please consult our website for current data (www.seametrics.com).

INSTALLATION



CAUTION: These water meters are not recommended for installation downstream of the boiler feedwater pump where installation fault may expose the meter to boiler pressure and temperature. Maximum recommended temperature is 120° (PVC) or 200° (Metal).

Piping Conditions. Installing the meter with 10 diameters of straight pipe upstream and 5 downstream is recommended.

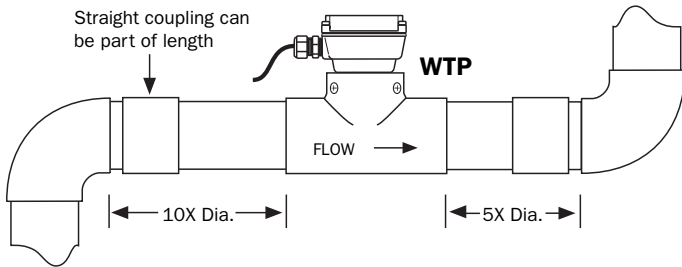

Flanges. For 3-8" WTC and WTS meters, standard flanges are 150 lb. ANSI drilling. 2" WTC or WTS meters and all PVC meters can be installed with optional flanges according to pipe manufacturer's recommendations. For PVC a bolt torque of 10-20 ft-lbs. for 2" flanges, 20-30 ft-lbs. for 3" and 4" flanges, and 35-50 ft-lbs. for 6" flanges is recommended.

Either partial or full-face gaskets can be used. Tighten the bolts evenly. Use care to prevent a misaligned gasket from entering the flow stream.

Position. The WT-Series are all-position meters, operable in a vertical or horizontal position, with the meter insert in any radial position. A horizontal position is preferred if there is a risk of air becoming trapped due to constant low flows. Operating the meter in partially-filled pipe will result in inaccuracies.

CONNECTIONS

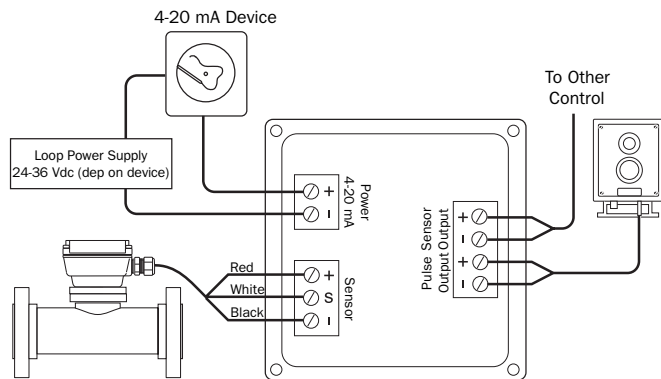

For operating instructions for the various electronic modules, consult the manual for the specific module, included with the meter at purchase.

WTC and WTS Meters

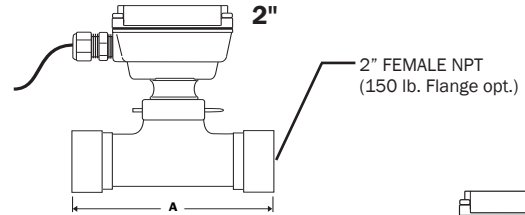

Size	Dim A
2"	* 8" / ±10"
3"	12"
4"	14"
6"	18"
8"	20"

*Without flange
±With flange

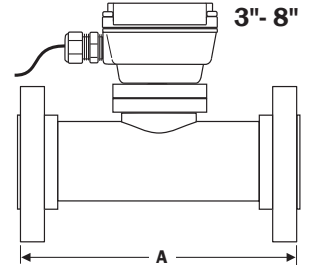

WTP Meter

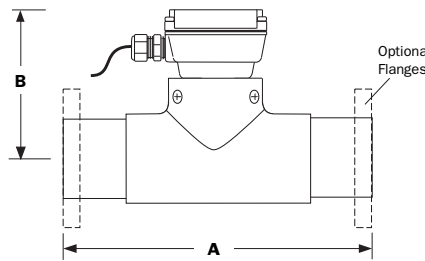

Size	A	B
2"	10"	7.5"
3"	12"	6.5"
4"	14"	7.0"
6"	18"	8.5"

MAINTENANCE and REPAIR

Recalibration. If it is necessary to recalibrate the meter for any reason, this can be done by any Seametrics-authorized facility. Call your supplier for information.

Turbine Insert Removal and Installation. CAUTION: First remove all pressure from the line. Then remove the screws or bolts that hold the insert in place (or the U-clip in the 2" meters) and tug gently until the insert comes free. A twisting motion can help to loosen the O-ring seal. Reverse the procedure to reinstall, after coating the O-ring with lubricant (plastic compatible in the WTP). Do not overtighten.

Rotor and Shaft Replacement. Examine the rotor to determine if bearings or shaft are damaged or excessively worn. The rotor should spin smoothly and freely, with no visible wobble. Back and forth play should be very minor, less than 1/64". If it is necessary to replace the rotor or shafts, first back out both shafts with a small blade screwdriver. The rotor will come free as soon as the shaft ends come free of the rotor bearings. Reverse the procedure to reinstall. **Note:** Do not overtighten the shaft screws. Check to be sure that a small amount of free play between the shaft ends and the bearings remains.

Sensor Replacement. This is rarely necessary. However, certain electrical conditions can damage the sensor. To replace it, first remove the electronics module. Disconnect the sensor leads from the electronics module terminals and remove the threaded plug over the sensor. Finally, remove the sensor by pulling on the sensor leads. A gentle tug should be sufficient. Reverse the process to replace the sensor.

REPLACEMENT PARTS

2" METERS		
1-6	Housing	see 3 - 8"
7	Strain relief	07655
8	Square housing adapter	Not Available
9	Pickup retaining screw	25321
10	Pickup, Micropower (for WT104)	29953
	Pickup, Standard (for WT101)	26310
11	O-ring, EPDM	25081
12	Insert	Contact Factory
13	Shaft assembly, ceramic (2 req)	16710 BEFORE 1-1-2011
14A	Rotor Assembly PVDF/bearing assembly	25947 BEFORE 1-1-2011
	Rotor repair kit, PVDF	25945 BEFORE 1-1-2011
14B	Rotor Assembly, Polypro/Tungsten Carbide	33015 AFTER 1-1-2011
	Rotor Repair Kit, Polypro/Tungsten Carbide	33087 AFTER 1-1-2011
15	U-clip, stainless	15527

3" - 8" METERS		WTC	WTP	WTS
1	Upper blind housing assembly	30475	30475	30475
1	Powered rate/totalizer	26949	26949	26949
1	Blind 4-20 mA transmitter	26521	26521	26521
1	Battery-powered rate/totalizer	26519	26519	26519
2	Lower housing gasket	26211	26211	26211
3	Lower housing	29930	29930	29930
4	Upper housing screw assembly (4 req)	26229	26229	26229
5	Plug, steel	26073	26073	26073
6	Water seal assembly	26079	26079	26079
7	Strain relief	07655	07655	07655
8	Square housing adapter	Part Not Replaceable		
9	Pickup retaining screw	25321	25321	25321
10	Pickup, Micropower (for WT104)	29953	29953	29953
	Pickup, Standard (for WT101)	26310	26310	26310
11a	Insert, 3"-8" WTC and WTS	26464	N/A	26464
11b	Insert, 3" PVC	N/A	26461	N/A
11c	Insert, 4"-6" PVC	N/A	26462	N/A
12	Shaft assembly, ceramic (2 req)	16710	16710	16710
	Shaft assembly, carbide (2 req)	30473	30473	30473
13	Rotor (PVDF) /bearing assembly	15316	25962	15316
14	O-ring, EPDM	25105	16426	25105
15	Insert screw (4 req'd)	N/A	07689	N/A

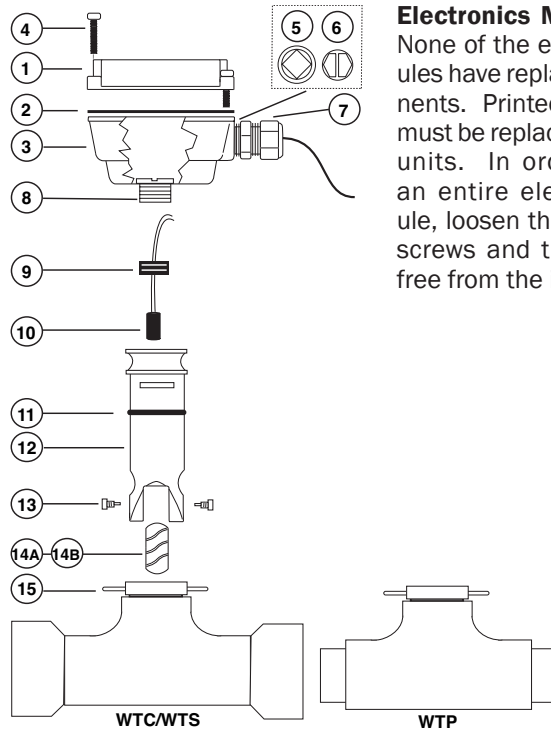

Electronics Module Repair. None of the electronics modules have replaceable components. Printed circuit boards must be replaced as complete units. In order to replace an entire electronics module, loosen the four retaining screws and the unit will lift free from the insert housing.

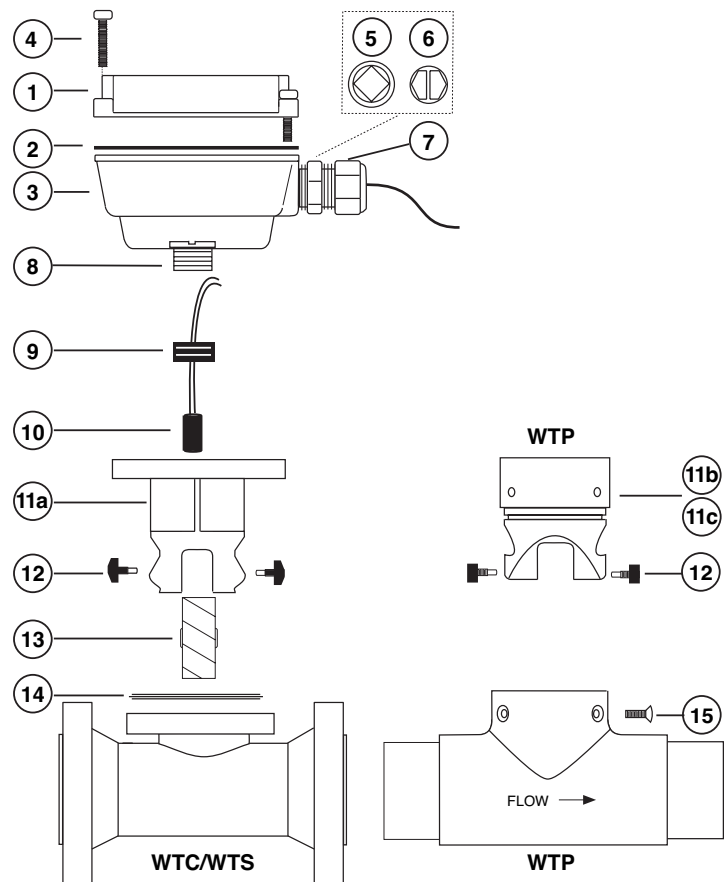

Seametrics Incorporated • 19026 72nd Avenue South • Kent, Washington 98032 • USA
 (P) 253.872.0284 • (F) 253.872.0285 • 1.800.975.8153 • www.seametrics.com