

Multipoint Systems™

For Sierra Series 640S Flow Meters

INSTRUCTION MANUAL

IM-Multipoint

Revision: A, May 2009



CORPORATE HEADQUARTERS

5 Harris Court, Building L Monterey, CA 93940
Phone (831) 373-0200 (800) 866-0200 Fax (831) 373-4402
www.sierrainstruments.com

EUROPE HEADQUARTERS

Bijlmansweid 2 1934RE Egmond aan den Hoef
The Netherlands
Phone +31 72 5071400 Fax +31 72 5071401

ASIA HEADQUARTERS

Rm. 618, Tomson Centre, Bldg A, 188 Zhang Yang Road
Pu Dong New District, Shanghai, P.R.China
Phone: + 8621 5879 8521 Fax: +8621 5879 8586

IMPORTANT CUSTOMER NOTICE

Sierra Instruments, Inc. is not liable for any damage or personal injury, whatsoever, resulting from the use of Sierra Instruments standard mass flow meters or controllers for oxygen gas. You are responsible for determining if this mass flow meter or controller is appropriate for your oxygen application. You are responsible for cleaning the mass flow meter or controller to the degree required for your oxygen flow application.

© COPYRIGHT Sierra Instruments TRADEMARKS

No part of this publication may be copied or distributed, transmitted, transcribed, stored in a retrieval system, or translated into any human or computer language, in any form or by any means, electronic, mechanical, manual, or otherwise, or disclosed to third parties without the express written permission of Sierra Instruments. The information contained in this manual is subject to change without notice.

TRADEMARKS

Multipoint System™ Dry-Sense™, and Steel-Mass™ are trademarks of Sierra Instruments, Inc. Other product and company names listed in this manual are trademarks or trade names of their respective manufacturers.

Table of Contents

CHAPTER 1: INTRODUCTION	4
Welcome to the Multipoint System™	4
Safety Information	5
Receipt Of Your Instrument	5
Definitions Used In This Manual	6
CHAPTER 2: INTRODUCTION TO THE MULTIPOINT	7
CHAPTER 3: INSTALLATION	8
Installation Guide	9
Connecting Modbus Communication to Individual Model 640S Meters	9
Installation: Daisy Chaining the Units Together	10
Installation: Installing Into Duct Or Pipe	11
Installation Depth Of The 640S In The Duct	11
CHAPTER 4: SETTING UP THE MENU	12
Advanced Menu	15
CHAPTER 5: TECHNICAL SUPPORT & SERVICE	17
Technical Support	17

CHAPTER 1: INTRODUCTION

Welcome to the Multipoint System™

Sierra's new Multipoint System™ builds upon the outstanding applicability of Sierra's Steel-Mass™ Model 640S. This system allows users to easily average the flow of 2-4 Model 640S Flow Meters. The Multipoint System™ uses a Human Machine Interface (HMI) for controlling and visualizing the process. It is also used to setup the individual meters, allowing the entire system to be easily configured in the field.

The Multipoint System™ is designed for bigger pipes or ducts and dynamically compensates for changes in the flow profile due to changes in flow. Flow is measured at multiple points in the pipe or duct and those flows are added together and divided by the number of points to get the grand average flow rate.

The Multipoint™ consists of up to four Model 640S flow meters linked via Modbus, one control box with touch-screen HMI and 4-20mA/0-5V output module, and the associated cables (power, output 4-20mA/0-5V, cable for daisy-chaining the 640S flow meters).

The Steel-Mass™ Model 640S Smart Insertion Mass Flow Meter is designed for the toughest industrial gas flow measurement applications.

The versatile microprocessor based transmitter integrates the functions of flow measurement, flow range adjustment, meter validation and diagnostics, in either a probe mounted or remote housing. Mass flow rate and totalized flow, as well as other configuration variables, are displayed on the HMI display. The programmable transmitter is easily configured via the Multipoint's HMI..

Sierra's State-of-the-art calibration facility insures that the calibration will match the application, and our patented Dry-Sense™ thermal sensor insures the Model 640S will hold this calibration over time. Visit the Sierra Instruments' website www.sierrainstruments.com or www.sierrawiki.com any time for more information about this product.

The Multipoint System™ offers a variety of features for ease of operation.

- ✓ **Averages the flow of 2-4 meters**
- ✓ **Convert units f.i. for NLPS to SLPH**
- ✓ **Setup density of the gas for mass flow measurement**
- ✓ **Setup of the individual meters**
- ✓ **Easy setup of the HMI system**
- ✓ **Alarm setup**
- ✓ **Touch screen operated**
- ✓ **And many more...visit www.sierrainstruments.com**

SAFETY INFORMATION

Caution and warning statements are used throughout this manual to draw your attention to important information.

Warning! 

This statement appears with information that is important to protect people and equipment from damage. Pay very close attention to all warnings that apply to your application.

Caution! 

This statement appears with information that is important for protecting your equipment and performance. Read and follow all cautions that apply to your application.

RECEIPT OF YOUR INSTRUMENT

When receiving the instrument, carefully check the outside packing carton for damage that may have incurred during shipment. If the carton is damaged, notify the local carrier and submit a report to the factory or distributor. Remove the packing slip and check that all ordered components are present and match your specifications (as ordered). Do not return any equipment to the factory without first contacting Technical Support Center.

DEFINITIONS USED IN THIS MANUAL

The following terms are used frequently in this manual. They are presented here with their definitions for your information.

FFS = Factory full scale of the 640S meter

UFS = User full scale of the 640S meter

HMI = Human machine interface

Note: It is recommended to you read:

“Sierra Steel-Mass™ Model 640S Insertion Mass Flow Meter Instruction Manual.”

CHAPTER 2: INTRODUCTION TO THE MULTIPOINT

Multipoint Systems™ are used for bigger pipes to dynamically compensate for changes in the flow profile due to changes in flow. The basic principle is that flow is measured at several locations in the pipe, then those points are added together and divided by the number of points to get the grand-average flow rate.

Multipoint consists of:

- 4 x 640S meters with modbus. (see Sierrainstruments.com for information about Model 640S meters)
- 1 x Control box, with HMI and 4-20mA/0-5V output module.
- 3 x cable's (power, output 4-20mA/0-5V, cable for daisy chaining the 640S meters)

In the default mode the four models of the 640S are added together and divided by four, but the operator can turn units On or Off. For example, if one unit is turned off the average is divided by three.

Each unit and total average can have a multiplication factor (the default is 1.00):

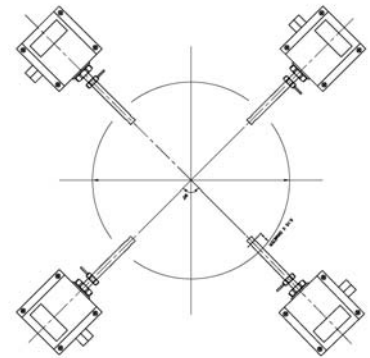

$$\text{Average} = \left(\frac{X1 * \text{Flow1} + X2 * \text{Flow2} + X3 * \text{Flow3} + X4 * \text{Flow4}}{4} \right) * X_{tot}$$

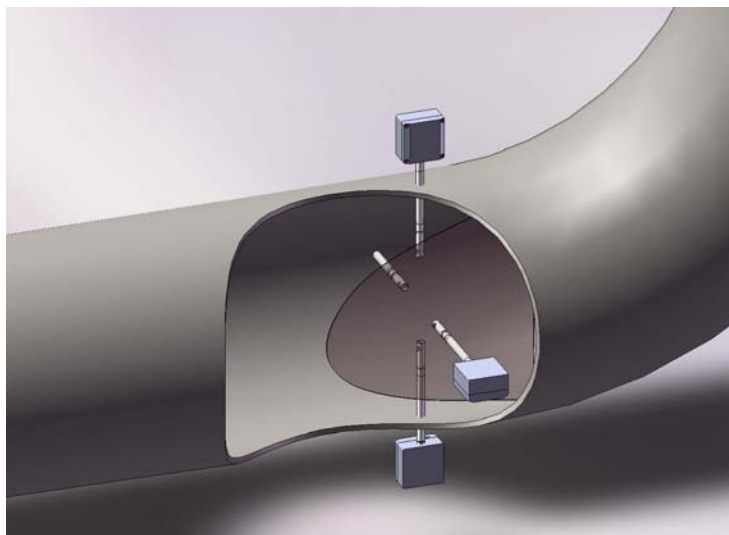

Figure 1: Sierra Instruments' Multipoint System Demo

CHAPTER 3: INSTALLATION



Wiring: The Multipoint System™ requires 24VDC approximately 2A.

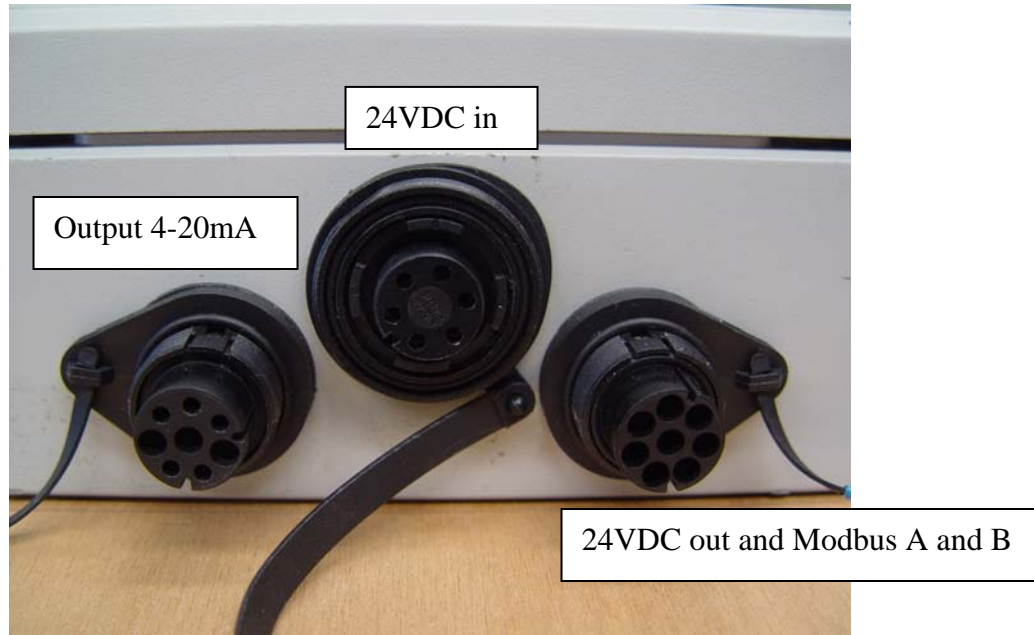
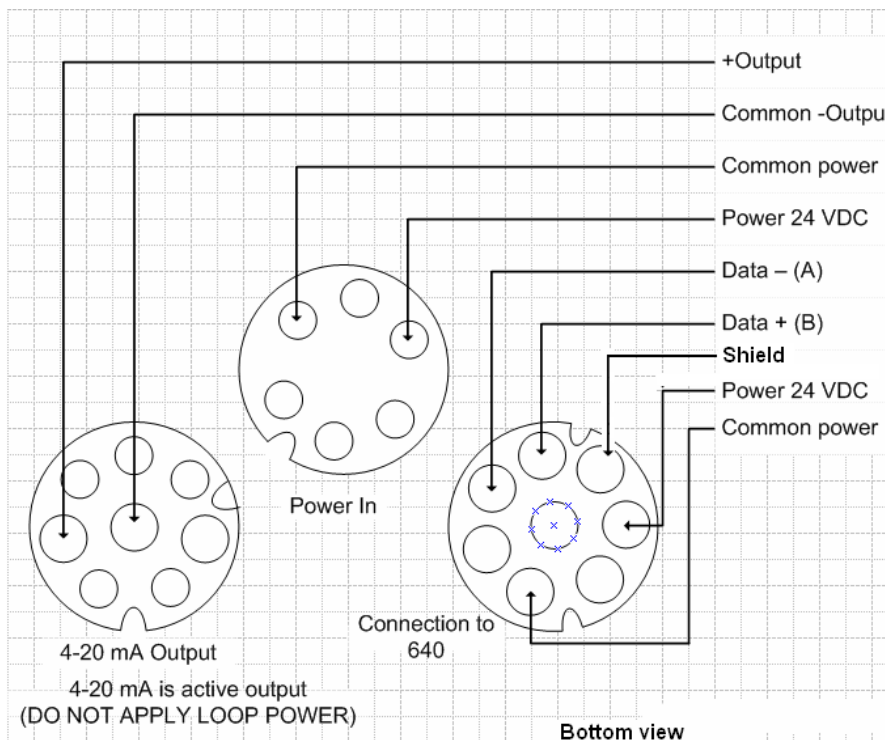

Figure 2: Wiring Ports on the HMI



All three connectors are different, they are keyed differently to prevent mistakes.

The middle connector is the 24 VDC Power supply in.

The left connector is 4-20mA output with the grand-average flow rate. This is an active output; do not apply loop power.

The right connector is for daisy chaining the 640 meters. This is a 4-wire daisy chain: two wires for the power supply and two wires for the modbus communication.

Figure 3: Pinouts of the HMI

Installation Guide

DC Power Wiring Individual Model 640S Meters

The DC power wire size must be 18 to 19 AWG with the wire stripped 1/4 inch (6 mm). Connect to the terminals marked (1)PWR+ and PWR(2)- on the terminal block. Torque all connections to 4.43 to 5.31 in-lbs (0.5 to 0.6 Nm).

All EEx installations must use an approved EEx fitting at both cable entries into the enclosure. If conduit seals are used, they must be installed within 18 inches of the enclosure.

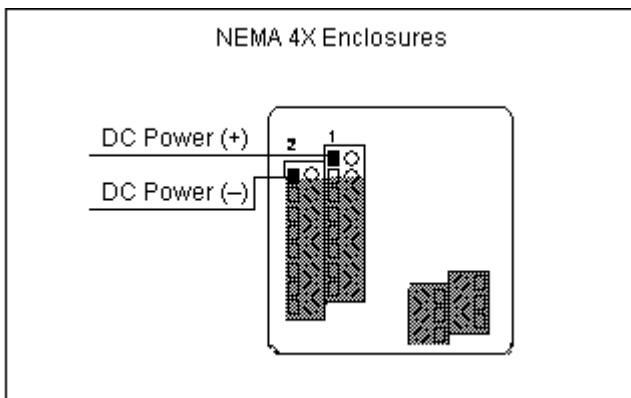

Figure 4: DC Power Wiring

Connecting Modbus Communication to Individual Model 640S Meters

After opening the enclosure, the modbus communication TB is visible on the right side.

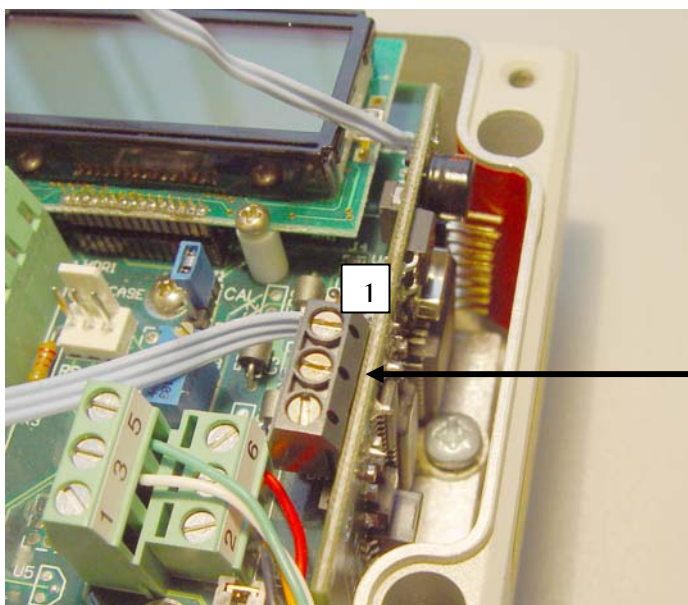
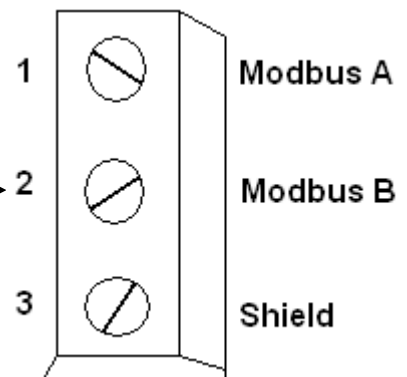

Figure 5: Modbus Wiring



Installation: Daisy Chaining the Units Together

Daisy chain the cable with the 4 x 640S meters as shown in the picture below and tighten the cable glands:

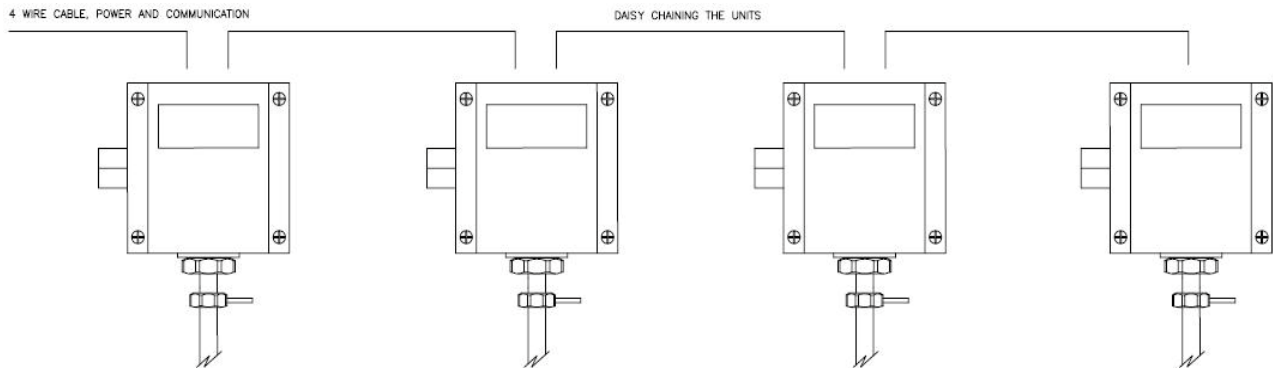
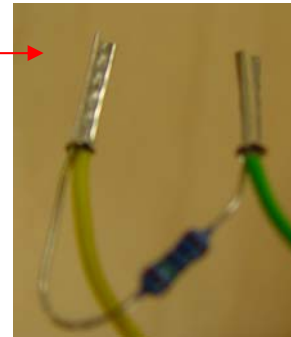

Figure 6: Daisy Chaining of 640S Units



Make sure that the last 640S meter (#4) has a terminator resistor between the yellow and green wire.



Daisy chain the modbus A and B for all four 640S meters to the connector of the HMI. The shield of the cable can be connected to the connector pin called shield (See Figure 2) and to the modbus communication print number 3 of the 3 way terminal.

The RS485 is an optical isolated interface. Don't connect the RS485 shield to ground of the power supply unless the isolated interface isn't required.

NOTE: The communication cable can not be longer than 1200m.

Installation: Installing into Duct or pipe

Installation Depth of the 640S in the Duct

If you don't know the flow profile or you are not familiar on how to determine the flow profile, there is a basic rule on how to set the depth of the 640S meters in the duct.

Be aware that this might not be the most accurate way for your application, knowing the flow profile and install according to that profile is preferred

Divide the duct in four equal quadrants. Insert the middle of the sensors of the probe to $0.15 \times D$ (D =diameter of the duct) into the duct. Make sure that the probes are turned 90° from each other. See picture below.

Although a multipoint theoretically compensates for distorted flow profiles it is recommended that there be as much straight length of pipe possible before the measurement point.

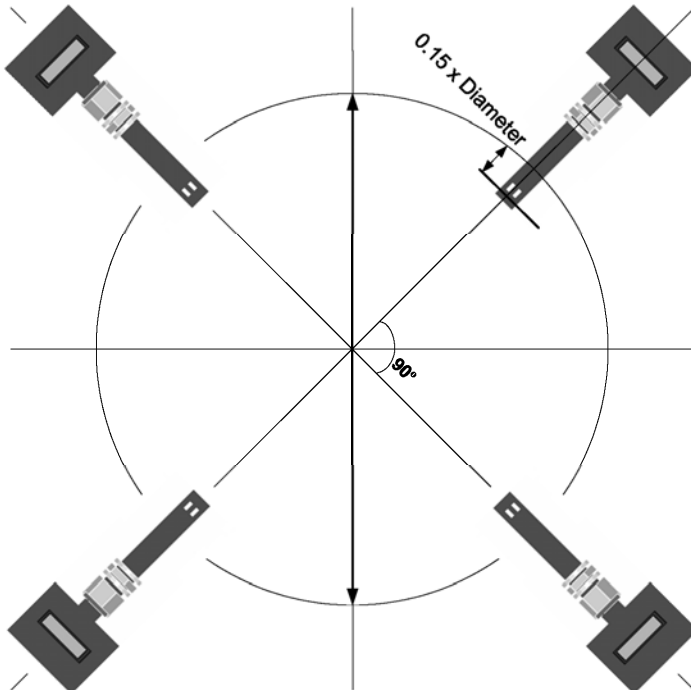

CHAPTER 4: SETTING UP THE MENU

Follow these screen shots to set up the Multipoint



- 1)
After power up the HMI initialize the system, this will take about 12 seconds. No action required.

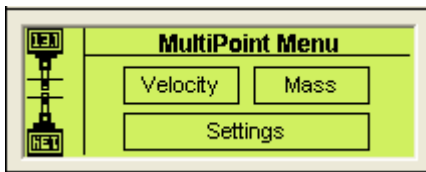

- 2)
After power up, the Multipoint Menu will appear. Begin setup of the Multipoint System™. This is done by pressing the “settings” button.

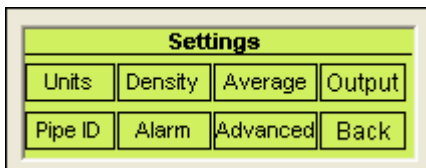

- 3)
First, press the “units” button to setup units. Here the user can also convert to other units.

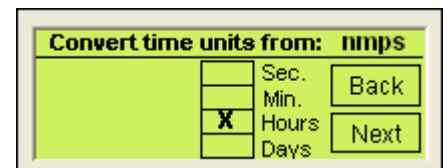
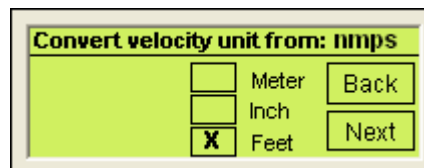
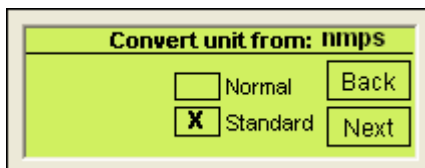

The original units of the meter are shown in the upper right corner. In this example they are normal meters per second (nmmps). Press the square box before the unit which you want to convert to, or if you don't want to convert the unit press the same unit. After pressing the square box your choice will be set by a cross. Press “next” button to proceed. In our example we have changed from NMPS to SFPH. *NOTE: All Multipoint meters start with a VELOCITY reading. Later steps will convert this into mass flow units like lbs/hr or SLPM if desired.*

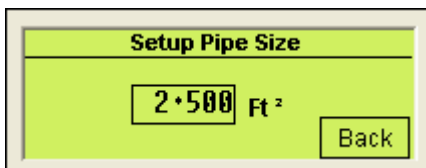

- 4)
Press the “pipe ID” button in the settings menu to setup the pipe diameter. This is not required if the user only want the velocity average.

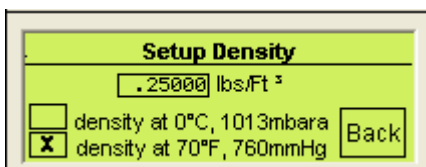

- 5)
Press the “Density” button in the settings menu to setup the Density of the gas. It is also required to fill in if the density is under normal or standard conditions, this is done by pressing the square box. The density is only required if you use the real mass average.

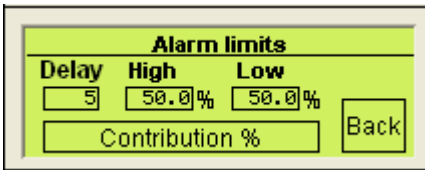

6) By pushing the “alarm” button in the settings menu the user can setup the alarm limits. If one of the 640S meters is out of the specified limits an alarm is enabled. The user can see a LOW or HIGH alarm. AN ALARM CONDITION TAKES THE METER OUT OF THE GRAND AVERAGE.

You can turn the unit on again in the average menu. Note that these additions or subtractions from the baseline. The assumed baseline is 100% of the AVERAGE FLOW. In this example for the high alarm the limit is entered as 50%. This means that the high alarm limit is set to 150% of the AVERAGE FLOW. For the low alarm it needs to be subtracted from 100%. In this example for the low alarm limit is entered 50% means that the low alarm limit is set to 50% of the AVERAGE FLOW. So you can see that if a single meter suddenly began to read less than half or more than 1.5 times the average flow (in this particular example), there is assumed to be a fault with that point and it is removed from the grand average.

There is also the possibility to set a delay, in seconds. When a meter is out of range a timer will start and if the flow recovers within this time the alarm will not go off.

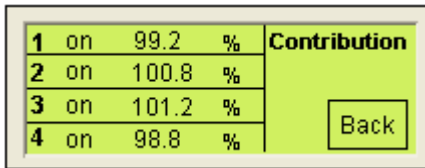

By pressing the “contribution” button in the alarm limits screen, the user can see what every meter measures in % of the average flow.

f.i: Unit 1, 2, 3 measures 10 NLPM and Unit 4 measures 9,2 NLPM. This is an average of $39.2 / 4 = 9.8$ NLPM. So unit 1, 2, 3 measures 102% and unit 4 measures 94%.

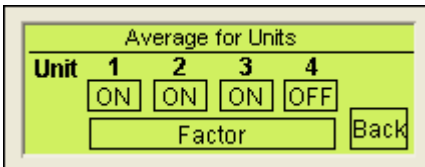

7) By pushing the “average” button in the settings menu the user can setup which meters will count for the averaging. The user can turn meters on and off for the averaging by toggling the On/Off button below the corresponding number. By pushing the “factor” button you can give every

meter a multiplication factor. Also you can give the whole average a multiplication factor. Default for every multiplication factor is 1.00

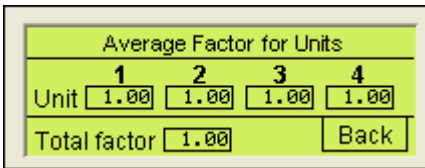

$$Average = \left(\frac{X1 * Flow1 + X2 * Flow2 + X3 * Flow3 + X4 * Flow4}{4} \right) * X_{tot}$$

X stands for the multiplication factor.

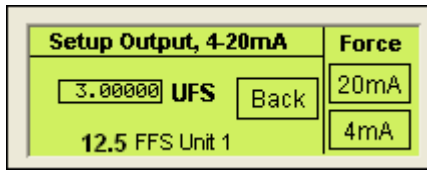

8) By pushing the “output” button in the settings menu the user can setup the 4-20mA output (the grand-average output). The output can be forced to 4 or 20 ma for testing by pressing 4 or 20 mA below Force. By pressing 4 or 20mA the output is forced to go to 4 or 20mA. The user is free to setup the output within the FFS of unit 1. In this screenshot the FFS of unit 1 is 12.5, but for UFS is 3.00 entered. Now at a flow of 3.00 the output is 20mA. The output is always 4mA if there is no flow. *The output is the average flow.*

9) Once the user has setup the Multipoint System™ to his requirements he can go back to the multipoint menu and choose velocity or Mass, with mass you can choose normalized/standardized or real mass flow.

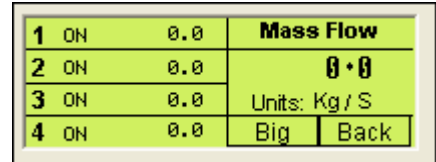
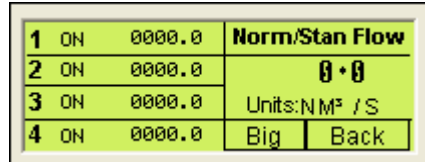
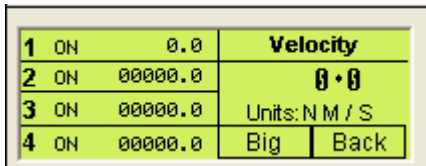

Information on the screen:

1, 2, 3, 4 stands for the corresponding Model 640S Flow Meter. You can see the individual flow for each point Flow and the grand average flow with units.

By pressing the Big button the user can see the average flow on one screen.

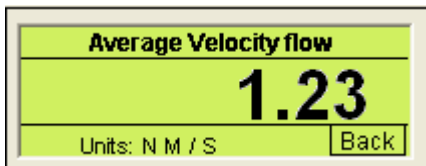

Advanced Menu

With the advanced menu, here the user can see all the parameters for the individual 640S meters. The user can enter this menu by pressing the “advanced” button in the settings menu.

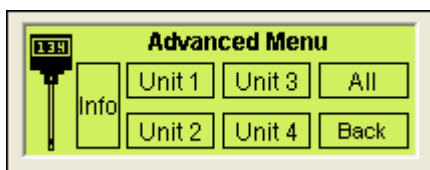

10) In the advanced menu the user can choose the unit he wants to see. By pressing the “All” button the user can see all four 640S meters.

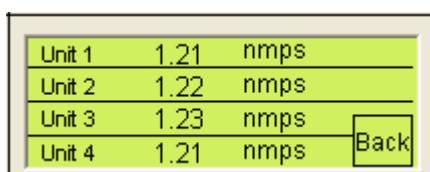

If the “All” button is pressed the user will see the flow and the original units for all four 640S meters.

NOTE: The units (example nmps) are the units in which the meters are original calibrated. This has nothing to do with the unit conversion in the Settings menu of the Multipoint System™

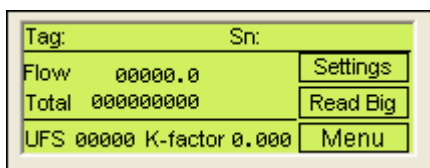

By pressing a unit in the advanced menu the user will see all the parameters of the individual meter. The parameters are Tag and Serial number, flow, totalizer, UFS and K-factor. By pressing the “Settings” button the user can change some settings.

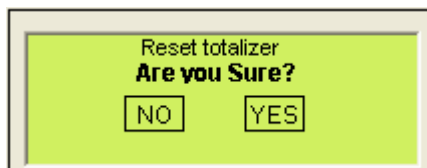
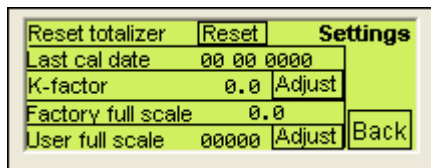

The user can reset the totalizer by pressing the “Reset” button and confirm with the “Yes” button.

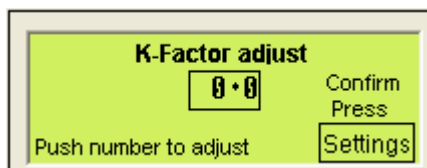
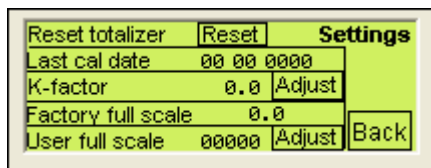

The user can change the k-factor by pressing the “Adjust” button behind the k-factor number. A screen will appear where the user can change the k-factor and confirm.

NOTE: Entering a k-factor adjusts the meters output signal without affecting the factory calibration curve. Use the k-factor calibration offset for additional flow profile compensation (the factory includes an initial flow profile correction in the calibration curve of the unit). If in doubt, read the manual “Sierra Series 640S Flow Meter”.

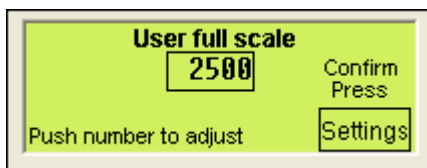
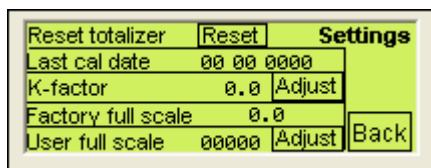

The user can change the UFS by pressing the “Adjust” button behind the User full scale number. A screen will appear where the user can change the User full scale and confirm.

NOTE: User Full Scale Flow Rate may be Field-configured from 50% to 100% of the factory full scale setting (factory full scale is normally set to 125% of the user-specified maximum flow rate). This adjustment can be made for each flow range. If in doubt read the manual "Sierra Series 640 Flow Meter".

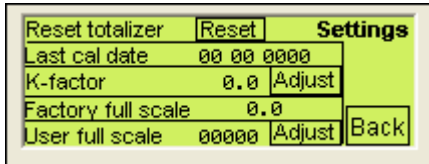

The settings screen also shows the last calibration date and the Factory Full Scale. Those are not changeable.

CHAPTER 5: TECHNICAL SUPPORT & SERVICE

Technical Support

If you encounter any problem with your instrument, review the configuration information for each step of the installation, operation, and set up procedures as explained in this manual. Verify that your settings and adjustments are consistent with factory recommendations.

If the problem persists, Sierra Instruments is eager to help you. You may contact us at the following Technical Support Center. It may also help to call your Sierra Instruments Sales Agent, who is also well trained in the operation of the product.

IMPORTANT: When contacting Technical Support, make sure you have included the following information:

- The type of Multipoint System™, serial number (all marked on the instrument data label).
- The problem you are encountering and any corrective action taken.

CUSTOMER SERVICE AND SUPPORT INFORMATION

Email Technical Support: service@sierrainstruments.com

Email Sales: sales@sierrainstruments.com

FACTORY USA:

TOLL FREE: 800-866-0200

PHONE: 831-373-0200

FAX: 831-373-4402

EMAIL: service@sierrainstruments.com

European Sales & Service Center:

PHONE: +31 72 5071400

FAX: +31 72 5071401

EMAIL: service@sierra-instruments.nl

Asia Sales & Service Center:

PHONE: + 8221 5879 8521

FAX: +8621 5879 8586

EMAIL: www.sierra-asia.com