

Model 515 Flow Computer

Operation Manual

Application BF03

Batch/Flow Controller
for
Mass Frequency Flowmeters



contrec

22 December 2005

Model 515 Flow Computer - Operation Manual

© Contrec Pty Ltd 2005

The instructions given herein cover the general description, installation, operation and maintenance of the subject equipment. Contrec Pty. Ltd. reserves the right, without prior notice, to make engineering refinements that may not be reflected in this manual.

Should any questions arise which cannot be answered specifically by this manual, they should be directed to Contrec Pty Ltd for further detailed information and technical assistance.

Contrec Pty. Ltd. will not accept any liability for either direct or consequential damages resulting from the use or misapplication of the contents of this manual.

Part of the software embedded in this product is eCos - Embedded Configurable Operating System, a trademark of Red Hat. Portions created by Red Hat are Copyright © 1998, 1999, 2000 Red Hat, Inc. (<http://www.redhat.com>). All rights reserved

The software in this product was in part provided by Red Hat and any express or implied warranties, including, but not limited to, the implied warranties of merchantability and fitness for a particular purpose are disclaimed. In no event shall the author be liable for any direct, indirect, incidental, special, exemplary, or consequential damages (including, but not limited to, procurement of substitute goods or services; loss of use, data, or profits; or business interruption) however caused and on any theory of liability, whether in contract, strict liability, or tort (including negligence or otherwise) arising in any way out of the use of this software, even if advised of the possibility of such damage.

Contrec Pty Ltd

22 Hall Street Hawthorn East, Melbourne 3123 AUSTRALIA
Tel: +61 3 9804 4200 Fax: +61 3 9822 8329
Email: sales@contrec.com.au

Contrec - USA, LLC

916 Belcher Drive Pelham AL 35124 USA
Tel: (205) 685 3000 Fax: (205) 685 3001
Email: contrec@contrec-usa.com

Contrec Europe Limited

PO Box 436 Sowerby Bridge, West Yorkshire HX6 3YA, UK
Tel: +44 1422 829 940 Fax: +44 1422 829 941
Email: sales@contrec.co.uk

Website: www.contrec.com.au

Publication No: 515-BF03-OM - 22 December 2005



Safety Notice

The information in this safety notice is for the prevention of injury to personnel and damage to the instrument.

The manufacturer assumes no liability for injury or damage caused by misuse of the instrument or for modifications made to the instrument.

Qualified Personnel

The instrument must be installed, operated and serviced by persons who have been properly trained and authorised. Personnel must read and understand this manual prior to installation and operation of the instrument.

Static Hazard

The 500 series flow computer uses high speed CMOS circuitry which is sensitive to static damage. The user should observe accepted safety practices for handling electronic devices, especially during servicing. Once the unit is installed, grounded and interconnected, the chances of static damage are greatly reduced.

Voltage Hazard

Before connecting power to the instrument, ensure that the supply voltage for the AC or DC input is suitable. The AC voltage rating is as stated on the serial number plate. Personnel should take all due care to avoid electric shock.

Welding Hazard

Do not perform electric welding in close proximity to the instrument or its interconnecting cables. If welding in these areas must be performed, disconnect all cables from the instrument. Failure to do so may result in damage to the unit.

Moisture Hazard

To avoid electrical faults and corrosion of the instrument, do not allow moisture to remain in contact with the instrument.

Contents

1 Introduction

Features	1
Overview	1
Calculations	2
Displayed Information	2
Main Menu Variables	2
Communications	3
Isolated Outputs	3
Relay Outputs	3
Software Configuration	3
Approvals	4

2 Specifications

General	5
Inputs	5
Outputs	5

3 Installation

Panel Mounting	7
Electrical Connection	8
Rear Panel Connections	8
Terminal Designations	8
Inputs	9
Frequency Input Connection	9
Logic Input Connection	10
Outputs	10
4-20mA Output Connection	10
Digital Output Connection	11
Control Relays	11
RC Network for Interference Suppression	12
Communications	13
RS-232 Port	13
Infra-red Port (Display Panel Option)	13
RS-485 Port (Advanced Option)	13
Earthing and Shielding	14

4 Operation

Front Panel Operation	15
Default Variable	15
Status Lamps	16
Front Panel Keys	16
Main Menu Items	16

Setting the Batch Preset	17
Setting the Flow Control Setpoints	18
Data Logs	18
Model Information	20
Flow Control Modes	20
Local Flow Control Mode	20
Loop Flow Control Mode	21
Loop Tuning Mode	21
Tuning the Control Loop	21
Batch Control Modes	23
Preset Mode	23
On-Off Mode	23
Release Mode	23
Batch Control Operation	24
Operation Configurations	24
Starting a Batch	25
Stopping a Batch	25
Resetting a Batch	26
Logic Input Control	26
Batch Errors	26
Batch Processes	27

5 Instrument Calibration

Introduction	29
Calibration View Mode	29
Calibration Set Mode	30
Changing the Instrument Settings	31
Calibration Menu Tree	32
Instrument Settings	34
Units of Measurement	34
Parameters	35
Inputs	39
Outputs	42
Alarms	44
Communications	45
Time Settings and Data Logging	47
General Setup Parameters	49
Test Menu	50
System Messages	51
Error Messages	52
Warning Messages	52

6 Communications

Overview	53
Hardware Interconnection	53
Protocols	55
Simple ASCII Protocol	55
Requests Format	56

Instrument Responses	57
Corrupted or Invalid Requests	60
Modbus RTU Protocol	61
List of Data Registers	62
Printer Protocol	67
Types of Printouts	67
Printer Data Control	70
Appendix A Glossary	
Glossary	73
Appendix B Model Numbers	
Product Codes	75
Custom Version Codes	76
Application Information Code	76
Appendix C Units of Measurement	
Available Units of Measurement	78
Index	79

List of Figures

1	500 Series Instrument Panel Mounting	7
2	Rear Panel Connections	8
3	Output 4-20mA Connection Diagram	11
4	Output Pulse Connection Diagram	11
5	External Relay Connection Diagram	12
6	RS-485 Interface Connections	14
7	Batch Operation with Manual or Automatic Reset	27
8	Batch Operation with Automatic Restart	28
9	Calibration Menu Tree Sheet 1	32
10	Calibration Menu Tree Sheet 2	33
11	RS-232 Cable Connections to a Computer	54
12	RS-485 Connections	54

Chapter 1

Introduction

Features

- Tailored for mass frequency flow input
- Single or Dual stage control
- Preset or manual On-Off modes
- Easy access to batch and flow rate presets
- No-flow, leakage and overflow error detection
- Remote RUN/STOP/RESET
- Uses PI Loop Control
- Protection against Integral wind-up
- Allows for non-linear correction
- Storage of 1000 transactions with time and date stamp
- Selection of second language and user tags
- Infra-red communications port on front panel
- Pulse width and scaling of pulse output
- 4-20mA retransmission
- Selectable protocols on serial ports including Modbus RTU and Printer output
- Front panel adjustment of 8-24V DC output voltage
- Backlit display
- LCD backup

Overview

The 515 BF03 application is a batching flow controller for delivery of preset quantities at preset flowrates using a mass frequency input. Batch control can operate in preset or on-off modes, while flow control can be set to local (manual) or PI loop mode.

This application provides the operator with clear local readout including flowrate deviation and can be controlled via communications in more automated systems. There is quick access to commonly used preset values directly from the front panel if access has been authorized.

The PI control of the process flow is via a 4-20mA proportional valve or pump controller. It has integral wind-up protection, a deadband, output hold and ramp time that can be programmed to reduce wear on valves and actuators and provide for bumpless operation.

Calculations

The total and flowrate are derived from accurately measured frequency and the number of received pulses.

$$mass = pulses / k\text{-factor}$$

$$mass\ flow = frequency / k\text{-factor}$$

Automatic overrun compensation calculates the new valve closure point to ensure correct delivery by averaging the overrun amount from the last three complete batches.

The overrun compensation value is valid for a new preset value provided the stored overrun is less than 20% of the new preset.

Displayed Information

The front panel display shows the current values of the input variables and the results of the calculations.

The instrument can be supplied with a real-time clock for storage of up to 1000 transactions with time and date stamps.

Main Menu Variables

Main Menu Variables	Default Units	Variable Type
Mass	kg	Total
Mass Flowrate	kg/min	Rate
Process Control Output	%	Rate
Process Flowrate Deviation	%	Rate

Refer to [Available Units of Measurement](#) on page 78 for the list of available units.

Communications

There are three communication ports available as follows:

- RS-232 port (standard)
- RS-485 port (advanced option)
- Infra-red port (on front panel)

The ports are available for remote data reading, printouts and for initial application loading of the instrument.

Isolated Outputs

The opto-isolated outputs can retransmit any main menu variable. The type of output is determined by the nature of the assigned variable. Totals are output as pulses and rates are output as 4-20mA signals. One output is standard, a second output is available as an option.

Relay Outputs

The relay outputs 1 and 2 are used to control the flow of product for each delivery. These contacts are normally open and can be used to drive external relays, valves, pump circuits etc. The advanced option provides another two relays that can be used as fully programmable alarms for any rate type variable.

Software Configuration

The instrument can be further tailored to suit specific application needs including units of measurement, custom tags, second language or access levels. A distributor can configure these requirements before delivery.

Instrument parameters including units of measurement can be programmed in the field, according to the user-access levels assigned to parameters by the distributor.

All set-up parameters, totals and logged data are stored in non-volatile memory with at least 30 years retention.

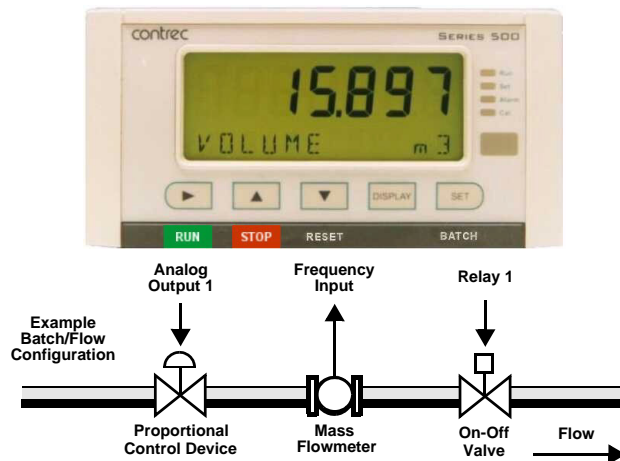

Approvals

This instrument conforms to the EMC-Directive of the Council of European Communities 89/336/EEC and the following standards:

- Generic Emission Standard EN 50081-1 Residential, Commercial & Light Industry Environment.
- Generic Emission Standard EN 50081-2 Industrial Environment.
- Generic Immunity Standard EN 50082-1 Residential, Commercial & Light Industry Environment.
- Generic Immunity Standard EN 50082-2 Industrial Environment.

In order to comply with these standards, the wiring instructions in [Chapter 3 - Installation](#) must be followed.

Chapter 2

Specifications

General

Operating Environment	
Temperature	-20°C to +60°C (conformal coating) +5°C to +40°C (no coating)
Humidity	0 to 95% non condensing (conformal coating) 5% to 85% non condensing (no coating)
Power Supply	95...135 V AC or 190...260 V AC or 12...28 V DC
Consumption	Typically 6W
Protection	Sealed to IP65 (Nema 4X) when panel mounted
Dimensions	147mm (5.8") width 74mm (2.9") height 167mm (6.6") depth

Display	
Type	Backlit LCD with 7-digit numeric display and 11-character alphanumeric display
Digits	15.5mm (0.6") high
Characters	6mm (0.24") high
LCD Backup	Last data visible for 15min after power down
Update Rate	0.3 second

Non-volatile Memory	
Retention	> 30 years
Data Stored	Setup, Totals and Logs

Approvals	
Interference	CE compliance
Enclosure	ATEX, FM, CSA and SAA approved enclosures available for hazardous areas

Real Time Clock (Optional)	
Battery Type	3 volts Lithium button cell (CR2032)
Battery Life	5 years (typical)

Inputs

Frequency Input (General)	
Range	0 to 10kHz
Overvoltage	30V maximum
Update Time	0.3 sec
Cutoff frequency	Programmable (default at 0.25Hz)
Configuration	Pulse, coil or NPS input
Non-linearity	Up to 10 correction points

Pulse	
Signal Type	CMOS, TTL, open collector, reed switch
Threshold	1.3 volts

Coil	
Signal Type	Turbine and sine wave
Sensitivity	15mV p-p minimum

NPS	
Signal Type	NPS sensor to Namur standard

Logic Inputs	
Signal Type	CMOS, TTL, open collector, reed switch
Overvoltage	30V maximum

Outputs

Relay Output	
No. of Outputs	2 relays plus 2 optional relays
Voltage	250 volts AC, 30 volts DC maximum
Current	3A maximum

Communication Ports

Ports	RS-232 port RS-485 port (optional) Infra-red port
Baud Rate	2400 to 19200 baud
Parity	Odd, even or none
Stop Bits	1 or 2
Protocols	ASCII, Modbus RTU, Printer (RS232)

Transducer Supply

Voltage	8 to 24 volts DC, programmable
Current	70mA @ 24V, 120mA @ 12V maximum
Protection	Power limited output

Isolated Output

No. of Outputs	1 configurable output (plus 1 optional)
Configuration	Pulse/Digital or 4-20mA output

Pulse/Digital Output

Signal Type	Open collector
Switching	200mA, 30 volts DC maximum
Saturation	0.8 volts maximum
Pulse Width	Programmable: 10, 20, 50, 100, 200 or 500ms

4-20mA Output

Supply	9 to 30 volts DC external
Resolution	0.05% full scale
Accuracy	0.05% full scale (20°C) 0.1% (full temperature range, typical)

Important: Specifications are subject to change without notice.

Chapter 3

Installation

Panel Mounting

The instrument should be located in an area with a clean, dry atmosphere that is also relatively free of shock and vibration.

The standard mounting procedure is panel mounting in a cutout that is 139mm wide by 67mm high. Two side clips secure the unit into the panel.

Figure 1 Figure 2 shows the panel mounting requirements for the 500 Series Instrument.

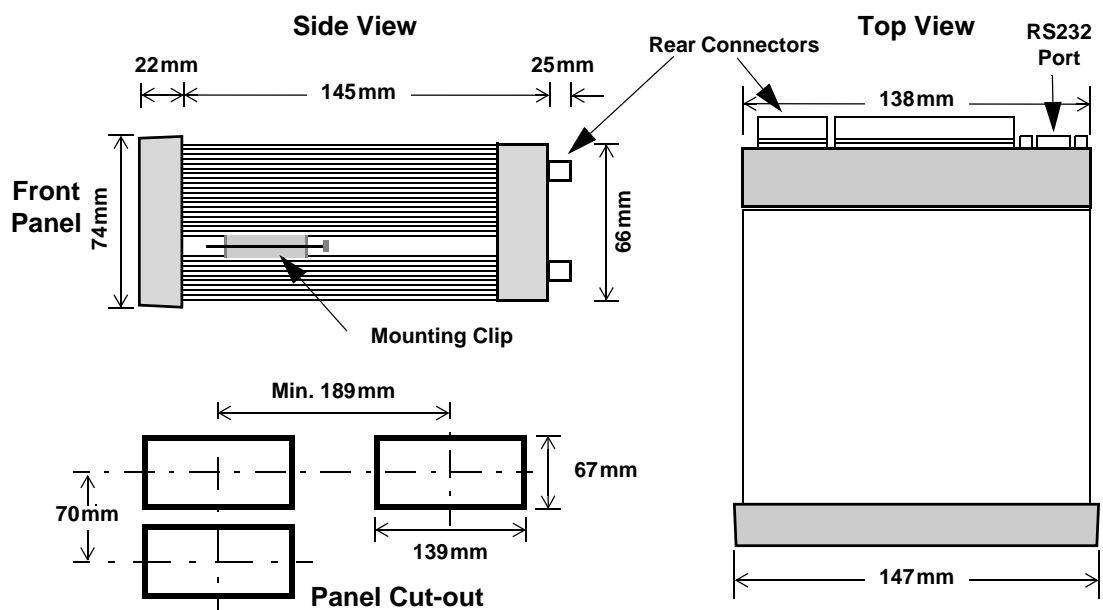

Figure 1 500 Series Instrument Panel Mounting

Electrical Connection

Rear Panel Connections

Figure 2 shows the connections on the rear panel of the instrument.

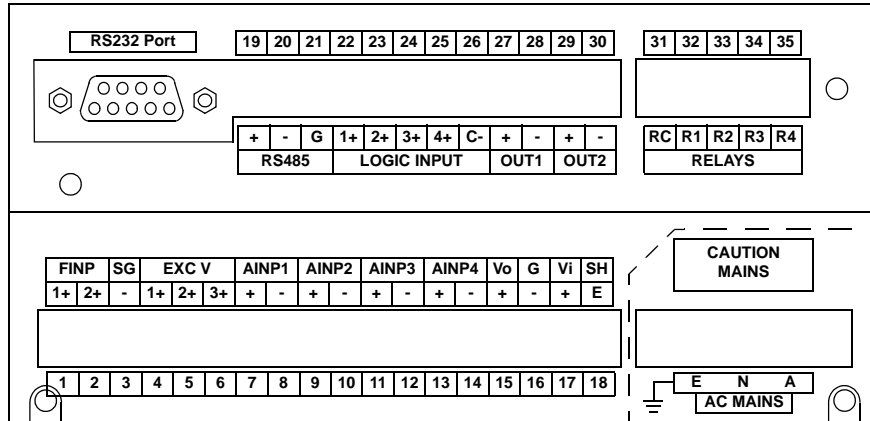

Figure 2 Rear Panel Connections

Terminal Designations

Terminal Label	Designation	Comment	Terminal Label	Designation	Comment
1	FINP 1+	Frequency Input 1+	19	RS485 +	RS485 (+)
2	FINP 2+	Frequency Input 2+	20	RS485 -	RS485 (-)
3	SG -	Signal ground	21	RS485 G	RS485 ground
4	EXC V 1+	Excitation Term 1+	22	LOGIC INPUTS 1+	Switch 1
5	EXC V 2+	Excitation Term 2+	23	LOGIC INPUTS 2+	Switch 2
6	EXC V 3+	Excitation Term 3+	24	LOGIC INPUTS 3+	Switch 3
7	AINP1 +	Analog input ch 1 (+)	25	LOGIC INPUTS 4+	Switch 4
8	AINP1 -	Analog input ch 1 (-)	26	LOGIC INPUTS C-	Signal ground
9	AINP2 +	Analog input ch 2 (+)	27	OUT 1 +	Output ch 1 (+)
10	AINP2 -	Analog input ch 2 (-)	28	OUT 1 -	Output ch 1 (-)
11	AINP3 +	Analog input ch 3 (+)	29	OUT 2 +	Output ch 2 (+)
12	AINP3 -	Analog input ch 3 (-)	30	OUT 2 -	Output ch 2 (-)
13	AINP4 +	Analog input ch 4 (+)	31	RELAYS RC	Relay common
14	AINP4 -	Analog input ch 4 (-)	32	RELAYS R1	Relay 1
15	Vo +	8-24 volts DC output	33	RELAYS R2	Relay 2
16	G -	DC Ground	34	RELAYS R3	Relay 3
17	Vi +	DC power input	35	RELAYS R4	Relay 4
18	SH E	Shield terminal		RS232 port	9-pin serial port
E	AC MAINS E	Mains ground			
N	AC MAINS N	Mains neutral			
A	AC MAINS A	Mains active			

Inputs

Frequency Input Connection

Connect pulse or frequency input signals from devices such as: TTL, CMOS, open collector, reed relay switch, coil and Namur proximity switch, as shown below. For better signal integrity, it is recommended to use shielded cable. Refer to [Terminal Designations](#) on page 8 for specific terminal numbers for this application.

Squarewave, CMOS or TTL

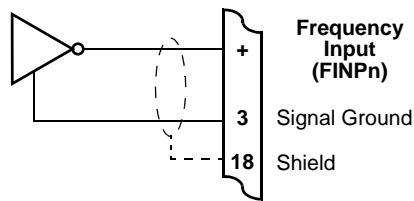

Open Collector

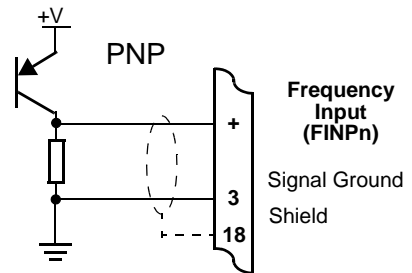
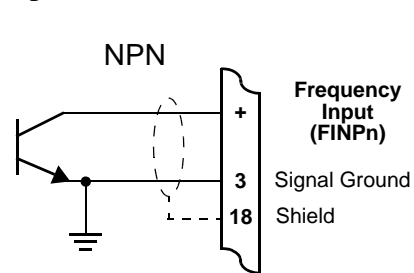

Reed Relay Switch

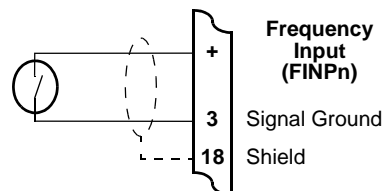

Coils - with 15 millivolts peak to peak AC minimum

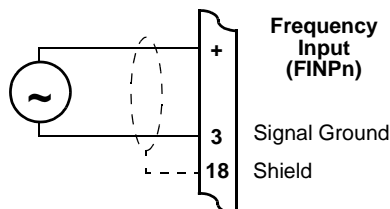

Namur Proximity Switch

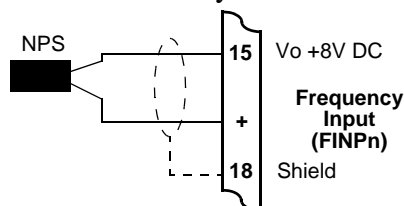

Logic Input Connection

These inputs are designed to be connected to CMOS, TTL, open collector signals or a voltage free contact switch. A minimum activation time of 300mS is required to guarantee reading of an input.

It is possible to read the status of all the logic inputs via a Modbus register even if they are not used for a control purpose in the application.

A remote push-button key can be connected to the Logic Inputs as shown below. **Logic Input Control** on page 26 describes the function of the inputs.

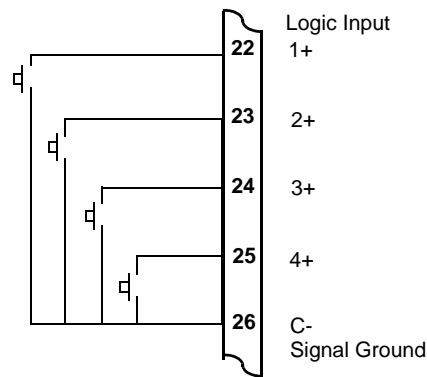

Outputs

The advanced option for the instrument provides two opto-isolated output ports. Either or both can be used for 4-20mA or pulse outputs.

CAUTION

Due to the dual-purpose nature of the outputs, take care not to set the output as an open collector pulse type signal when connected to a 4-20mA loop circuit.

4-20mA Output Connection

Figure 3 shows the connections for a 4-20mA output. Output channel 1 uses terminals 27 (+) and 28 (-), output channel 2 uses terminals 29 (+) and 30 (-).

Maximum Load Resistance = (Supply-9) / 0.02 ohms

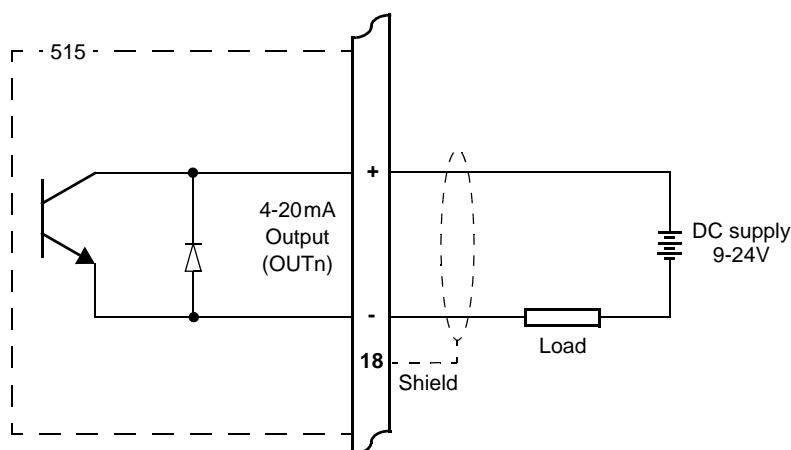

Figure 3 Output 4-20mA Connection Diagram

Digital Output Connection

Figure 4 shows a connection example for a pulse output. Output channel 1 uses terminals 27 (+) and 28 (-). Output channel 2 uses terminals 29 (+) and 30 (-).

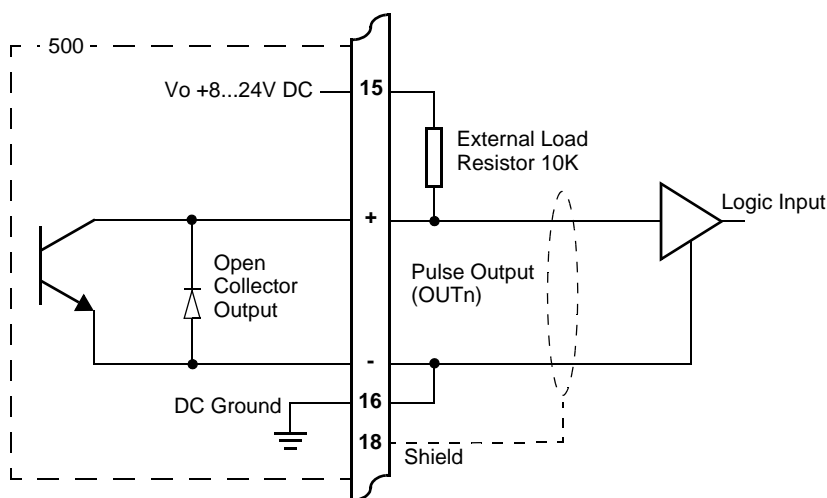

Figure 4 Output Pulse Connection Diagram

Control Relays

The standard instrument has two relays, which are used for the dual stage batch control. The relays can drive external devices such as external relays, valves, pump circuits, lamps, and audible alarms. The operation of each relay can be set in calibration to determine at which points in the process the relays open or close. The advanced option has two extra relays that can be freely assigned as alarm relays.

There is also an equipment failure alarm option. This alarm has normally closed contacts which open when the instrument displays any error message as listed in [Error Messages](#) on page 52, or if there is a loss of power to the instrument.

The output characteristics of the relays are:

Maximum Voltage 30 volts DC or 250 volts AC

Maximum Current 3 A

Figure 5 shows the connection of the relays.

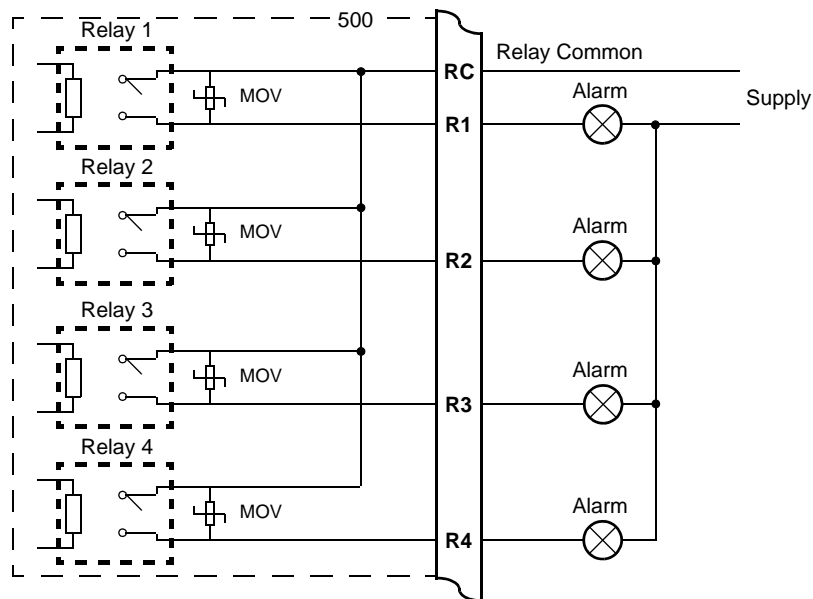

Figure 5 External Relay Connection Diagram

RC Network for Interference Suppression

When driving highly inductive loads with the relay outputs, it is recommended to use RC suppression networks (often called “Snubbers”) for the following reasons:

- To limit the amount of electrical noise caused by arcing across the contacts, which may, in extreme cases, cause the microprocessor to act erratically.
- To protect the relay contacts against premature wear through pitting.

RC suppression networks consist of a capacitor and series resistor and are commonly available in the electrical industry. The values of R and C are dependent entirely on the load. However, if the user is unsure of the type of snubber to use, values of 0.25 μ F and 100 Ω will usually suffice. Note that only mains-approved RC suppression networks should be used.

The basic principle of the operation is that the capacitor prevents a series of sparks arcing across the contact as the contact breaks. The series resistor limits the current through the contact when the contact first makes.

Communications

The communication protocols are described in [Communications](#) on page 53.

RS-232 Port

The RS-232 port has a 9-pin DB female connector and has the following pinout:

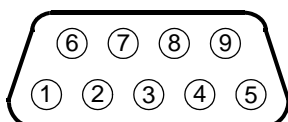

Pin 1	Not used
Pin 2	Transmit (TxD)
Pin 3	Receive (RxD)
Pin 4	Not used
Pin 5	Ground
Pin 6	Not used
Pin 7	Handshake line (CTS)
Pin 8	RTS Out
Pin 9	Not used

Note: The instrument does not require a null-modem cable for connection to a personal computer. Refer to [Hardware Interconnection](#) on page 53 for cable termination requirements.

Infra-red Port (Display Panel Option)

The infra-red port is located at the front panel, directly below the row of status indicators. The main function of this port is for retrieving current or logged data with a PC that has an infra-red port.

RS-485 Port (Advanced Option)

Up to 32 units can be connected to a common RS-485 bus. Each unit has a unique address that the host computer uses to identify each instrument.

Figure 6 shows the connection of several instruments to a computer using the RS-485 port.

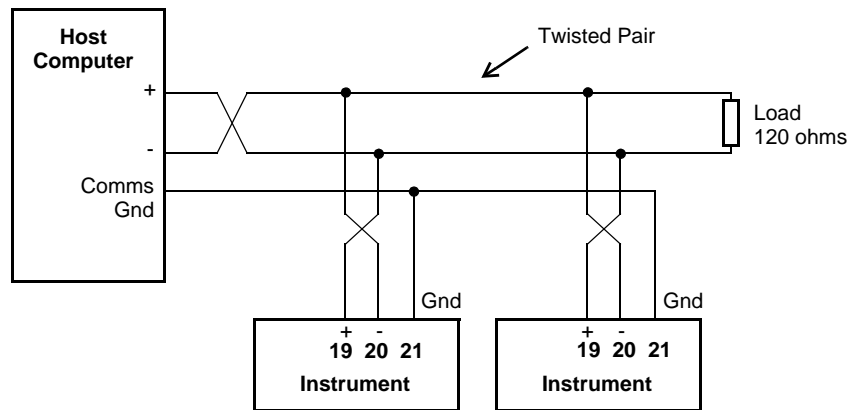

Figure 6 RS-485 Interface Connections

Earthing and Shielding

It is a good practice to use shielded cable for all signal connections to the instrument. Care must be taken to separate signal cables from power cables to minimize interference.

Overall earth should be connected at the instrument end only. This connection should be as short as possible and connected to the earthing point on the rear terminal at pin 18.

Chapter 4

Operation

Front Panel Operation

This instrument is a batch computer that is capable of controlling the rate of flow during a delivery. Batch control can be via a Preset or an On-Off mode, while flow control can be via a Local (manual) or Loop (PI control) mode. The controller can be used in any combination of these modes to achieve the required functionality.

In normal operation, you press the buttons on the front panel to control the operation of the batch controller or to display the values recorded and calculated by the instrument.

There are several categories of information that the instrument can display:

- Totals
- Rates
- Batch preset values
- Flow control values
- Instrument settings

For each total, there is an associated rate as follows:

Total	Rate
Mass	Mass Flowrate

Default Variable

In some applications, a particular variable is of more interest than others, and for this reason a default variable can be assigned during instrument calibration. The default variable is used in the following ways:

- Determines what total the batch and preset is to be based upon.
- Determines what the display returns to if the display timeout option is enabled and no buttons are pressed for the selected period (usually 30 seconds). It also determines what is displayed on power up.

Status Lamps

The status lamps illuminate to show the following conditions:



- Run** Solid led: The instrument has a batch in progress.
Flashing led: Fast, batch paused. Slow, waiting for valves to close.
- Set** Solid led: The instrument is in Calibrate Set mode.
Flashing led: Count down to automatic restart of next batch.
- Alarm** The instrument has an error, as indicated on the display panel.
- Cal** The instrument is in Calibrate View mode.

Front Panel Keys

RUN Press the **RUN** key to start or resume a batch. The run led will illuminate.

STOP Press the **STOP** key to halt a current batch. The instrument will go into pause mode and the run led will flash at a steady pace. The incomplete batch can be resumed. Also used to stop the next batch if in automatic restart count down.

RESET Use the **RESET** key to clear the batch totals or to initiate a printout if the printer option has been selected. The print is activated with a single press while the reset of the totals requires a press and hold for two seconds.

The instrument makes three beeps when it resets the totals and two beeps when a printout is started.

DISPLAY Press the **DISPLAY** key to step or scroll through the main menu items.

BATCH Hold the **BATCH** key to display the current batch preset value. Continue to hold for two seconds to enter edit mode for the preset if access is authorised. Pressing the **BATCH** key briefly displays the accumulated total.

Main Menu Items

The main menu in this instrument consists of the following items. The **DISPLAY** key is used to step or scroll through the list. The full menu can only be viewed if the batch controller has been stopped and reset.

DISPLAY ↓	Description	Options
MASS	Mass	Hold the SET key to display (or edit) the batch preset or briefly press to view the accum total
P-FLOW	Process flowrate	Hold the SET key to display (or edit) the controlling setpoint
P-CTRL	Process control output	Hold the SET key to display (or edit) the controlling setpoint

DISPLAY ↓	Description	Options
DEVIAT	Process flowrate deviation	Hold the SET key to display (or edit) the controlling setpoint
REPORT PRINT	Only shown if print option is selected	Hold the SET key to print log report as defined in the TM/LOG section of calibration.
LOGGED DATA	Only shown if real-time clock option is installed	Hold the SET key to display data logs as described in Data Logs on page 18.
MODEL INFO		Hold the SET key to display the Model information as described in Model Information on page 20.
CAL MENU		Hold the SET key to enter Calibration View mode as described in Calibration View Mode on page 29.

Setting the Batch Preset

SET The batch preset can only be set while the instrument is in the non-operational state, i.e. batch is complete or has been stopped and reset. Hold the **SET** key to display the current preset value while viewing the total variable. The display of the preset will change from view mode to edit mode after 2 seconds if access has been enabled in calibration. Once in edit mode the **Set** indicator will illuminate and the preset value can be changed in the same way as in calibration set mode, see **Changing Numeric Settings** on page 31. The **SET** key is used to exit edit mode.

Limit on Batch Size

To prevent accidental entry of large batch quantities, a maximum batch limit can be programmed during calibration. The operator is then prevented from entering a batch quantity which exceeds this value.

Common Preset Values

If the batching application continually uses a regular set of preset values then quick access can be provided to these. In calibration, there is the opportunity to enter up to 10 commonly used preset values.

These can then be accessed whilst in batch edit mode (described above) by pressing the **DISPLAY** key. The pre-programmed values will appear in the order they were entered in calibration. The display will step through the presets back to the currently entered value which can still be manually edited. While displaying the desired preset value, press the **SET** key to accept the value and exit edit mode.

Setting the Flow Control Setpoints

- SET** Hold the **SET** key to display (or edit) the controlling setpoint while viewing one of the “rate” variables. The display of the setpoint will change from view mode to edit mode after 2 seconds if access has been enabled in calibration. Edit mode can not be entered if a “Preset” batch is in progress. Once in edit mode the **Set** indicator will illuminate and the setpoint values are changed in exactly the same way as in calibration set mode.

Data Logs

The instrument will log up to 1000 deliveries (batches) if the real-time clock option is installed. The logs are taken at the end of each batch or upon reset if a batch has been aborted before the preset total has been reached. Each entry has a log number, a delivery number and a time and date stamp.

When the number of log entries exceeds 999 the oldest log entry is overwritten by the newest one.

View Data Logs

Use the following procedure to view the data that has been logged by the instrument:

1. Press the **DISPLAY** key to scroll through the menu to the **LOGGED DATA** prompt.
2. Hold the **SET** key.

The system displays the most recent log record first. The log record number and corresponding delivery number are shown, for example LR-001 and DEL 1236.

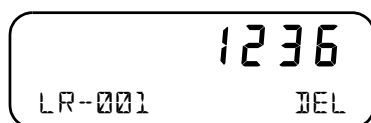

3. Use the **▲** or **▼** keys to scroll to the delivery number or log record of interest.
4. Press the **DISPLAY** key to show the information stored in the selected log record. Each log record consists of:
 - time and date stamp,
 - error code
 - totals for the delivery.
5. While holding the **DISPLAY** key use the **▶** key to step through the stored information.

6. While holding the **DISPLAY** key use the **RESET** key to print the data for the displayed log if the printer option has been selected.

The following example shows the format of the time and date stamp at 15:25 (3:25 pm) on 16 January 2004. The day and month alternate with the year in the bottom right hand corner.

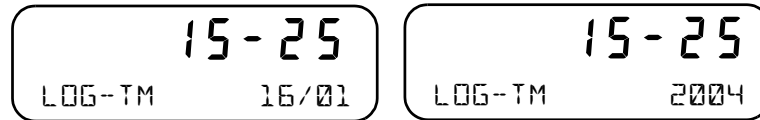

Model Information

The model information items display the hardware, software and application versions of the instrument. This information is mainly for service personnel.

<div style="border: 1px solid black; padding: 2px; display: inline-block;">DISPLAY</div> ↓	Description
- 11 - F - 515 MODEL	The hardware model code. Refer to Product Codes on page 75 for more information.
F - - - - BF03 INPUT	The Application number and the assignment of the inputs. Refer to Application Information Code on page 76 for more information.
0 10 1.002 BF03 VERS	The version of software loaded into the instrument.
026357 CUSTOM VERS	The Customer version code for this installation. Refer to Custom Version Codes on page 76 for more information.
123456 ABC123 S/N	The instrument serial number and unit tag. The serial number is on the top line and unit tag is on the bottom left. Both items are entered when the instrument application software is initially loaded. If the unit tag is not used the default tag, UNIT, will be used.
16 - 15 EDITED 27/08 2002	<p>The time and date when the calibration of the instrument was last edited. The format of the time and date is the same as for the data logs. This example shows 16:15 (4:15pm) on the 27th August 2002.</p> <p>This function is available only if the instrument has the real time clock option.</p>

Press SET at any time to exit from the Model information.

Flow Control Modes

This instrument can operate in the following flow control modes:

- Local (manual) mode
- Loop mode
- Tune mode (only available in calibration set mode)

Local Flow Control Mode

The desired process control output (P-CTRL %) is manually set via the front panel or serial communications.

The output signal is used to control a proportional control valve or variable speed drive to obtain the desired flow. In this mode the flow deviation (DEVIAT %) is set to zero.

Loop Flow Control Mode

The desired process flowrate set point (P-FLOW SP) is set via the front panel or serial communications.

The PI controlled output signal is used to maintain the desired process flowrate via a proportional control valve or variable speed drive.

Loop Tuning Mode

Tune Mode - CAL MODE ONLY

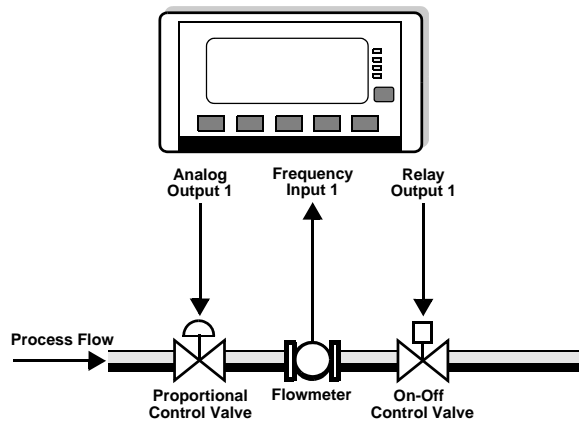

This mode is only accessed from within calibration mode and allows the operator to view a concise list of key parameters and gain immediate feedback. The Proportional Band (P-BAND) and Integral Time (I-TIME) are entered to tune the system.

For details on this method see below: **”Tuning the Control Loop”**.

The **RELEASE** prompt in batch mode is used to open the On-Off control valve from within calibration.

Tuning the Control Loop

The Process Controller has a special control mode, within the Parameters section of calibration, to assist in tuning the control loop. This mode provides a concise list of key parameters and allows for immediate feedback. The basic principle in tuning the loop is to gradually adjust the Proportional Band (P-BAND) and the Integral Time (I-TIME) and observe the response to a step change in the setpoint.

The tune menu provides for this by allowing the P-BAND and I-TIME to be programmed and then a Process Flow (P-FLOW) setpoint value to be entered. The next items in the menu are the actual live process variable and the deviation from the target value, so that the response of the system to a setpoint change can be observed. Unless the menu is quit the program will step back to start of the tuning menu so that new values of P-BAND and I-TIME can be entered and the effect of a step change in the setpoint be monitored.

As the idle position for any On-Off control valve in a batching system is “closed”, a special option in the Batch Mode parameter, RELEASE, allows the valve to be opened from within calibration. For more information, refer to [Release Mode](#) on page 23.

This sequence is used for Loop mode. The tuning procedure is as follows:

- 1.** Before tuning the control loop it is essential to program in the correct parameters for the flowmeters, including filtering.
- 2.** The actual Process Flow Range (P-FLOW RANGE) should be measured and entered. It is determined by setting the Control Mode to LOCAL, Batch Mode to RELEASE, setting the *Flow Setpoint* (control output) to 100% (20mA) and then observing the steady state flowrate.
- 3.** With the correct Process Flow Range entered and Batch Mode still set to RELEASE the Control Mode should now be set to LOOP to continue the tuning procedure.
- 4.** With the Loop Error Deadband (D-BAND) and the Output Ramp Time (R-TIME) set at zero, the I-TIME should be set to zero (disabled) and the P-BAND set at 150%.

Gradually decrease the P-BAND value until the system begins to oscillate when a small step change of the setpoint is introduced. When this occurs, double the value of the P-BAND.

- 5.** Next set the I-TIME to 20 seconds and gradually decrease the value until the system again begins to oscillate when a small step change of the setpoint is introduced. When this occurs double the value of the I-TIME.
- 6.** The Deadband and the Output Ramp Time can now be programmed as required.

The system should be tuned around the flowrate at which the eventual system will operate. The stability of the loop should then be checked at various flowrates and setpoints.

Batch Control Modes

This instrument can operate in the following Batch control modes:

- Preset mode
- On-Off mode
- Release mode (only available in calibration set mode)

Preset Mode

If the batch mode is **PRESET** the prestop and shut-off points are determined by the instrument.

The instrument can be set to count up from zero or down from the preset value. A slow flow start feature and reduction of flowrate when approaching the desired quantity is available for smoother batching. The automatic overrun compensation feature can be used to improve accuracy and repeatability. An auto-restart feature for automated repeat batches is also available in preset mode.

On-Off Mode

If the batch mode is **ON-OFF** the shut-off point is determined by the operator.

The instrument will operate in a count up direction. The slow flow start feature can still be used, but in this mode starting and stopping is determined by the operator and in this mode there is no End of batch output signal.

Release Mode

The **RELEASE** prompt in batch mode is used to open the On-Off control valve from within calibration, primarily for tuning and commissioning purposes.

The RUN led is illuminated while the On-Off valve is “open”. The type of flow control while the valve is open is dependent on the control mode at the time. If in LOOP mode PI Loop flow control is activated.

For PI Loop tuning procedures that may need the flow to be “released” for a considerable time it is important that the flow is directed to an appropriately sized vessel.

If calibration is exited while in Release mode the On-Off valve will close and the batch mode will default to Preset mode.

Batch Control Operation

Operation Configurations

For batch control this instrument can be used in three main configurations:

- Config 1. Using flow control output plus 1 control relay
- Config 2. Using flow control output only (no relays)
- Config 3. Using 2 control relays (no flow control)

Configuration 1

Flow Control & 1 Relay

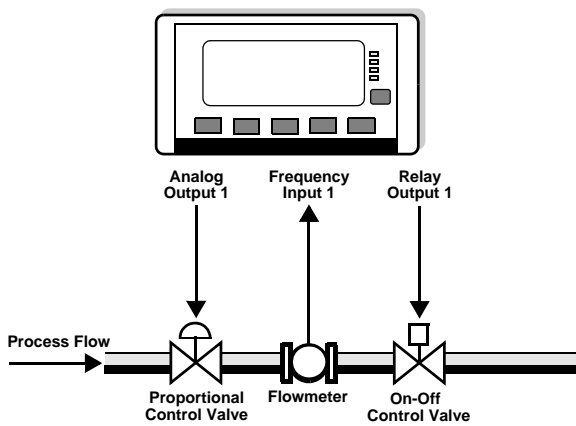

The Hold Output feature can be used in this configuration to provide a faster return to the desired flowrate when the next batch is started.

The analog flow control output can be used to operate either a proportional control valve or a variable speed drive.

The On-Off control value allows the system to achieve high accuracy batching.

Configuration 2

Flow Control Only (no relays)

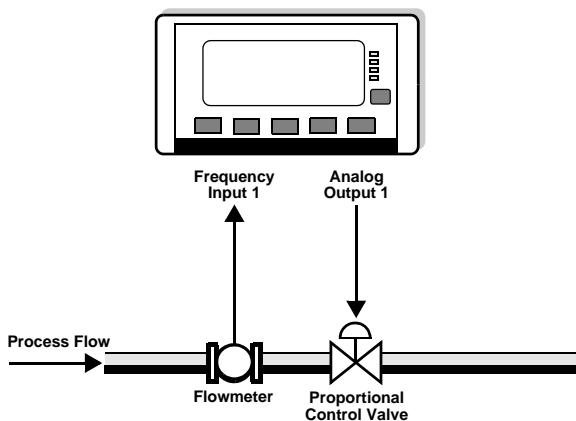

The Hold Output feature must be disabled in this configuration as the system relies on the proportional control valve to completely stop the flow.

While this system uses less hardware it is not recommended when high accuracy batching is required.

Configuration 3

2-Stage Relay Control (no flow control)

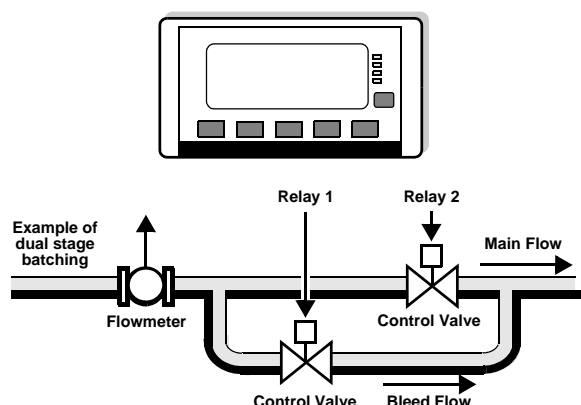

The batch controller can still be used in a conventional dual stage configuration. The Control Mode should be set to Local and the analog flow control output remains unused.

Parameters for slow start and prestop points are provided to control the operation of Relay 2.

A digital output can be programmed as a pump control signal if required.

Starting a Batch

To start the process the **RUN** key is pressed. The RUN led will illuminate and the instrument will begin to totalise from zero or, if programmed for Preset and count down mode, the display will decrement from the preset quantity.

The batch controller's analog output and two relays can be used to control the delivery of product. These are energised and de-energised as described below.

Stopping a Batch

The process can be stopped at any time by pressing the **STOP** key. Once the process has been interrupted in this way it can be continued by pressing the **RUN** key or the batch can be aborted and the instrument reset by pressing the **RESET** key.

When the process is interrupted it is in pause mode and the RUN led will flash to prompt the operator to restart or abort the batch.

Resetting a Batch

The instrument can be programmed to reset by different means.

- At the end of a batch, the **RESET** must be pressed to reset the batch total. If the instrument is programmed to count down, the display will revert to the preset value. If it is programmed to count up or is operating in On-Off mode, the batch total will clear to zero. The next batch can not be started until the previous batch total has been reset.
- If Auto Reset is enabled in the parameters section of calibration, the batch total will automatically reset when the **RUN** key is pressed for the start of the next delivery.

Logic Input Control

This instrument allows for remote operation via the logic inputs on the rear terminals. The logic input have the following functions:

- Logic Input 1 - Remote Run
- Logic Input 2 - Remote Stop
- Logic Input 3 - Remote Reset

For connection details, refer to **Logic Input Connection** on page 10.

Batch Errors

The instrument has the ability to raise an alarm when it detects a loss of flow, an overflow or a leakage in the system.

- **No Flow Error** - The no flow condition is detected when the flow timeout expires during a delivery. There must not be a period of no flow greater than the timeout value during the delivery.
- **Overflow Error** - The overflow condition is detected when the flow continues longer than the timeout period after the controller has attempted to stop the flow.
- **Leakage Error** - The leakage condition is detected when an amount greater than the acceptable total is received without flow being initiated by the batch controller.

The point at which these errors are detected is dependant on the values programmed into the calibration parameters Batch Flow Timeout and Acceptable Total. The open collector outputs can be assigned to activate whenever one of the flow errors occur. Refer to [Instrument Settings](#) on page 34 for more details.

Batch Processes

The batch controller can be programmed during calibration to operate in various ways including:

- Manual Reset (manual start).
- Automatic Reset (manual start).
- Automatic Restart for continuous batches (Preset Mode only).

In each of the above modes and configurations the parameters can be programmed to determine the behaviour and timing of relays and output signals. The following figures provide examples of some batch operations. Refer to [Instrument Settings](#) on page 34 for more details.

Manual and Automatic Reset

If Manual Reset the **RESET** key must be pressed at the end of the batch to clear the batch total. This must be done before another batch can be started. If Automatic Reset is programmed, a new batch is commenced each time the **RUN** key is pressed.

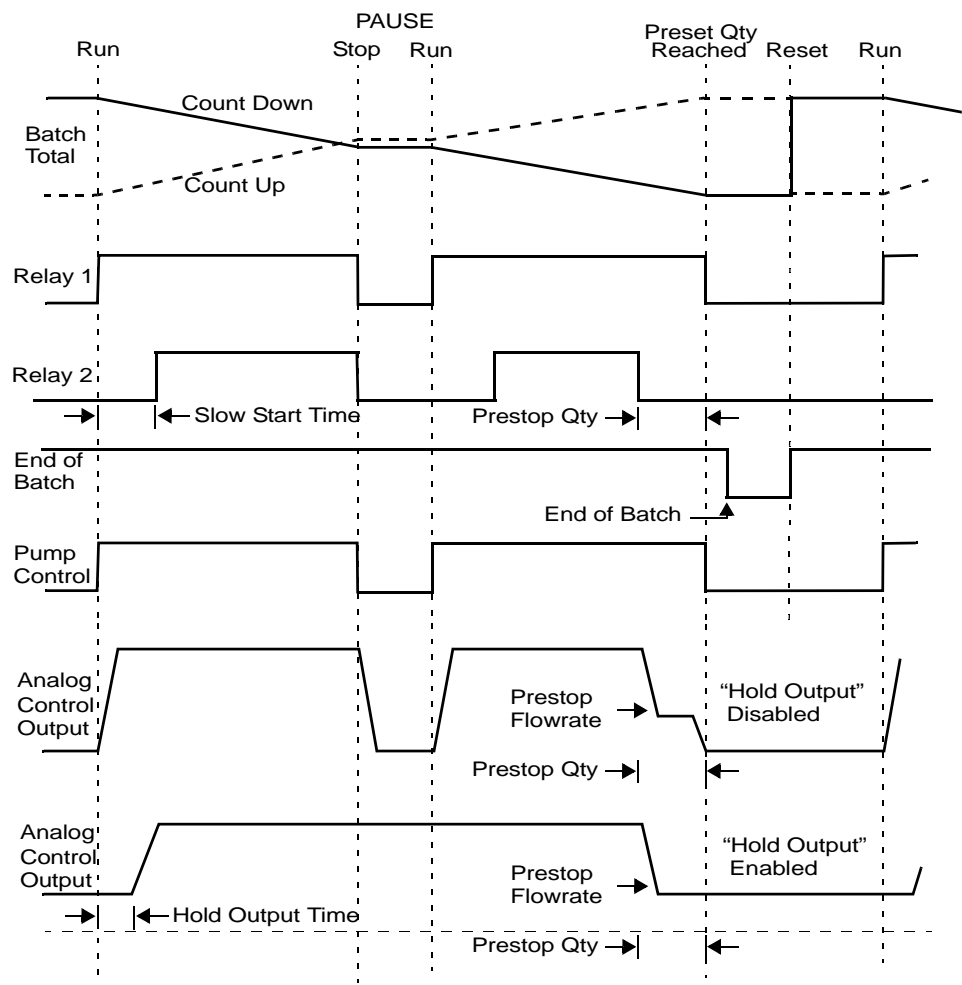

Figure 7 Batch Operation with Manual or Automatic Reset

Automatic Restart

If Automatic Restart is enabled the next batch will commence automatically when the restart timer expires after the end of batch has occurred. The SET led will flash while the instrument is waiting to automatically restart.

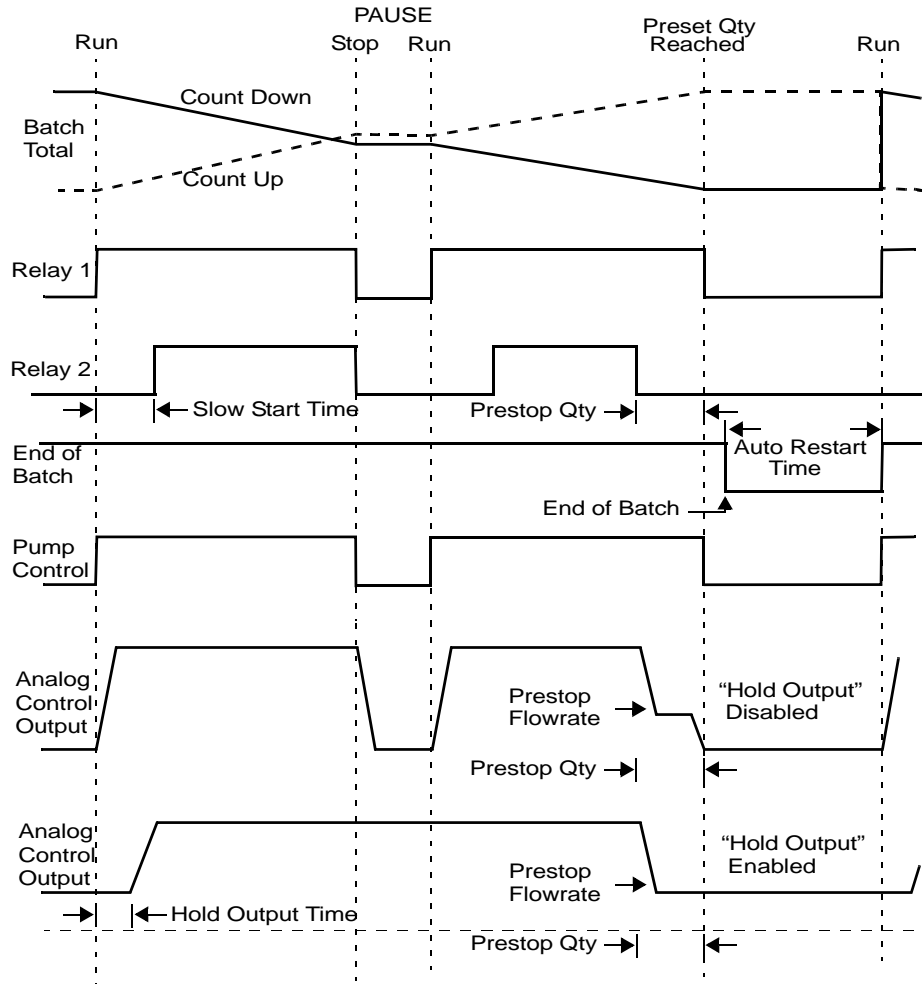

Figure 8 Batch Operation with Automatic Restart

Chapter 5

Instrument Calibration

Introduction

You can view or change the settings of the instrument according to the access level for each parameter as set by the manufacturer. There are four levels of access to the parameters as follows:

- **Not visible** - you cannot display or edit the parameter.
- **Display Only** - you can display the parameter, but you cannot change the setting.
- **Programmable** - you can change the setting of the parameter in Calibration Set mode.
- **Password protected** - you can change the setting of the parameter in Calibration Set mode only if you enter the correct password.

Note: When you enter Calibration Set mode, the instrument requests you to enter a password. You can enter any “incorrect” password to change the settings of the “programmable” parameters. You must enter the correct password to change the password-protected parameters.

Calibration View Mode

Use the following procedure to view the calibration settings of the instrument:

1. Press **DISPLAY** to scroll to the **CFM MENU** prompt.
2. Hold the **SET** key.



The instrument beeps once, illuminates the **Cal** indicator and shows **CFM** on the display panel.

- Press **▶** to scroll through the flashing menu headings.
 - Press **SET** to scroll through submenu items.
 - Press **DISPLAY** to return to the main calibration menu.
3. To exit from the Calibration View mode, press **▶** to scroll to the **END** option and press **SET**.

The instrument returns to Normal Operation mode.

Calibration Set Mode

In Calibration Set mode, you can change the settings of the “programmable” parameters. You must enter the system password to change the setting of the “password-protected” parameters.

Use the following procedure to enter Calibration Set mode:

1. Press **DISPLAY** to scroll to the **FL MENU** prompt.
2. Hold the **SET** key.



The instrument beeps once, illuminates the **Cal** indicator and shows **FL** on the display panel.

3. Press **▶** to select any flashing menu heading except **END**.
4. Hold **SET** for two seconds.

The instrument requests a password.

5. Press **▲** or **▼** to change the value of the current digit. To select the next digit, press **▶**.
6. Press **SET** to accept the password.

- The instrument makes two beeps for a correct password entry and enables you to change the “programmable” and “password-protected” parameters.
- The instrument makes one beep for an incorrect password entry and enables you to change only the “programmable” parameters.



The instrument illuminates both the **Cal** and **Set** indicators.

7. Edit the instrument parameters as required. The programmable values are indicated by the flashing display.
 - To change a numerical value, press **▲** to increase a value, or press **▼** to decrease a value. Press a key momentarily to change the value one number at a time. Hold a key to scroll through the numbers. To proceed to next digit, press **▶**.
 - To change an option setting, press **▲** or **▼** to scroll through the options.
8. Press **SET** to accept the currently displayed value and proceed to the next parameter. You can press **DISPLAY** to return to the main calibration menu.
9. To exit from Calibrate Set mode, press **▶** to scroll through the main calibration menu to **END**, then press **SET**. Otherwise, from any menu, you can press and hold **SET** for two seconds.





The instrument makes two beeps and cancels the **Cal** and **Set** indicators.

Changing the Instrument Settings

In Calibration Set mode, the display flashes the item that can be changed. For option settings, the display flashes the complete option. For a numeric parameter, the display flashes one digit at a time, you can change the value of the flashing digit as required, then move the flashing cursor to change another digit.

Note: When you change the setting of a parameter, the instrument records the result as soon as you move to another parameter, or exit from the Calibration Set mode.

Changing Option Settings

When you display an option that can be changed, the entire option flashes on the display, such as the choices of ODD, EVEN or NONE for the communications parity bit checking. Press  or  to change the option. You can “scroll” through the options in either direction to make a selection as shown below.

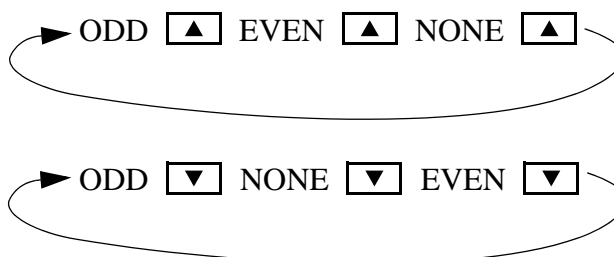

Changing Numeric Settings



The display flashes the digit that can be changed.



Press  to select the digit that you wish to change.

Press  or  to increase or decrease the value of the selected digit.

Changing the Decimal Point

To change the position of the decimal point, press  to move the flashing selection until the decimal point flashes. Press  or  to move the decimal point to the right or left as required.

Units of Measurement

The calibration of some parameters is based on the units that are defined for the relevant variables. These units of measurement can be viewed in the UNITS menu in calibration below.

Calibration Menu Tree

Figure 9 and Figure 10 show the keys for moving around the calibration menu tree in Calibration View or Set mode.

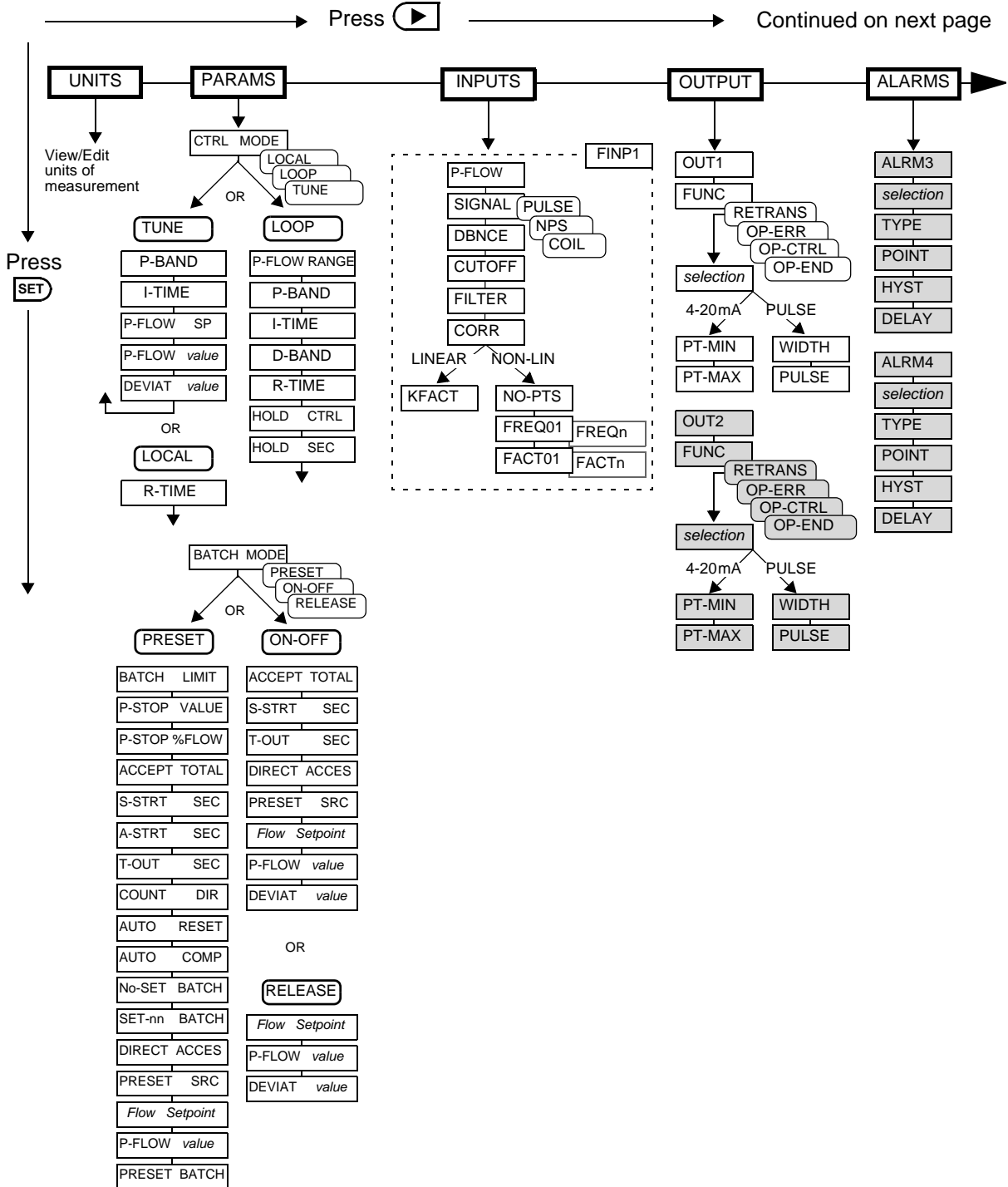

Figure 9 Calibration Menu Tree Sheet 1

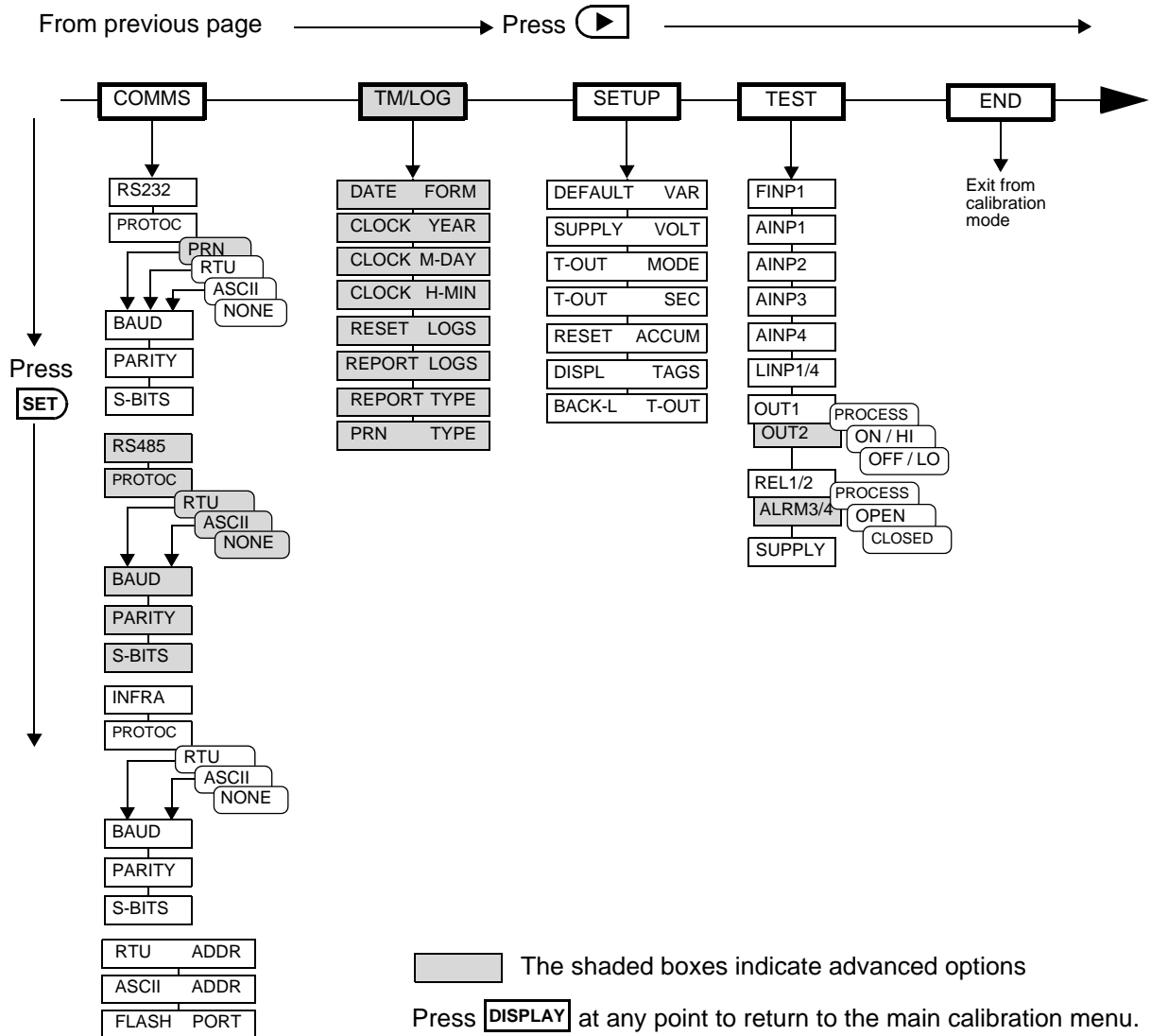









Figure 10 Calibration Menu Tree Sheet 2

Instrument Settings







Units of Measurement

The Units menu allows the units to be viewed and edited if necessary without the reloading of new application software. Any change in units will result in a full reset to initially downloaded settings. Therefore, any required changes to units of measurement should be made before changing any other settings.

 ↓	 → UNITS PARAMS INPUTS OUTPUTS ALARMS COMMS TM/LOG SETUP TEST END
ITEM <i>n</i> <i>unit</i>	<p>The units for main menu or calibration items can be viewed by pressing the  key.</p> <p>The units of measurement are password protected. To edit the units the correct password must be entered on entry to EDIT mode.</p> <p>Press  or  to select the required units. Refer to Available Units of Measurement on page 78 for the list of available units.</p>
ACCEPT UNITS	<p>The Accept Units prompt will only appear if one or more of the units have been changed.</p> <p>IMPORTANT: Accepting the change of units will initiate a master reset. All calibration parameters will revert to their default value (i.e. those values included in the downloaded instrument software). All totals and any logged information will be cleared.</p> <p>Press  or  to select YES, then press the  key. The instrument makes three beeps to confirm the reset command.</p> <p>The message -RESET- PLEASE WAIT will be displayed as the instrument exits calibration mode and completes a full re-boot sequence.</p>

Parameters

SET ↓	▶ → UNITS PARAMS INPUTS OUTPUTS ALARMS COMMS TM/LOG SETUP TEST END
CTRL MODE	<p>Select the required loop control mode.</p> <ul style="list-style-type: none"> • LOCAL - Manual control operating mode. • LOOP - PI loop control operating mode. • TUNE - PI loop control tuning mode. <p>Press <input type="button" value="▲"/> or <input type="button" value="▼"/> to select either: LOCAL, LOOP or TUNE.</p> <p>Refer to the section Control Modes for descriptions of each mode.</p>
<p>Note: The flow control items actually shown in the PARAMS menu are dependent on the CONTROL MODE chosen above. Items that are not relevant for that mode will not appear. Use the Calibration Menu Tree as a guide to the relevant items.</p>	
P-FLOW RANGE	<p>The process or loop flow range is the maximum flowrate that the system will achieve on the process flow line. This value is used by the loop control algorithm and is entered in the same units as the main menu Process Flowrate variable. It can be determined by setting the process control setpoint to 100% whilst in LOCAL mode and observing the flowrate.</p>
P-BAND %	<p>The proportional band of PI control algorithm.</p> <p>Enter the value in percentage. For means of determining this value see Tuning the Control Loop on page 21.</p>
I-TIME SEC	<p>The loop integral time of PI control algorithm. This parameter should be programmed as a non-zero value to enable the integral term in the control algorithm.</p> <p>Enter the value in seconds. For means of determining this value see Tuning the Control Loop on page 21.</p>
D-BAND %	<p>The loop error deadband can be programmed to prevent the output continuously changing and thereby reducing wear on valves and actuators. Enter the value as a percentage.</p> <p>While the main menu Deviation Percentage (error) is within the deadband, the process control signal will remain steady (i.e. the error is treated as zero in the algorithm).</p>
R-TIME SEC	<p>The ramp time limits the rate of change of the loop output signal and assists in bumpless loop operation when changing operation mode or loop parameters. It represents the minimum time required for the output signal to traverse between saturation points (i.e. from 0 to 100% or vice versa).</p>

		 → UNITS PARAMS INPUTS OUTPUTS ALARMS COMMS TM/LOG SETUP TEST END
HOLD CTRL		<p>The hold control output feature leaves the output signal at its last value at the end of a batch (flow should be stopped by the on-off valve).</p> <p>This allows the control actuator to start a new batch without ramping up from a fully closed position.</p> <p>Press  or  to select ENABLE or DISABLE.</p>
HOLD SEC		<p>The hold control output time determines when the loop control takes over after a batch starts or resumes. This can provide time for the on-off valve to open and flow to reach a stable flowrate before the systems resumes loop control.</p>
BATCH MODE		<p>Select the required batch control mode.</p> <ul style="list-style-type: none"> • PRESET - Preset delivery. • ON-OFF - Manual delivery. • RELEASE - Release flow (loop tuning, only available in calibration mode). <p>Press  or  to select either: PRESET, ON-OFF or RELEASE.</p> <p>Refer to the section Batch Modes for descriptions of each mode.</p>
<p>Note: The batch control items actually shown in the PARAMS menu are dependent on the BATCH MODE chosen above. Items that are not relevant for that mode will not appear. Use the Calibration Menu Tree as a guide to the relevant items.</p>		
BATCH LIMIT		<p>The batch limit determines the maximum batch preset value that can be entered. If a value of zero is entered for this parameter then no limit is applied.</p> <p>Enter the value in the engineering units of the batch preset.</p>
P-STOP VALUE		<p>The prestop value determines when relay 2 deactivates and the control output reduces as the batch approaches the preset quantity.</p> <p>Enter the value in the engineering units of the batch preset.</p>
P-STOP %FLOW		<p>The batch prestop flowrate is programmed as a percentage of the loop/process flowrate setpoint and is used to slow the flow the flow during the prestop stage of batching.</p>

<input type="button" value="SET"/> ↓	<input type="button" value="▶"/> → UNITS PARAMS INPUTS OUTPUTS ALARMS COMMS TM/LOG SETUP TEST END
ACCEPT TOTAL	<p>The acceptable batch total determines when a leakage error is raised. An error is detected if an amount greater than the acceptable total is received without flow being initiated by the batch controller. It also allows small totals due “meter skips” and vibration to be discarded without being considered as a valid delivery.</p> <p>Enter the value in the engineering units of the batch preset.</p>
S-START SEC	<p>The batch slow start time determines when relay 2 activates after the start or resumption of a batch.</p> <p>Enter the value in seconds.</p>
R-START SEC	<p>The batch automatic restart time determines the time that will elapse between the end of one batch and the start of the next. A value of zero disables the auto restart feature.</p> <p>Enter the value in seconds.</p>
T-OUT SEC	<p>The batch flow timeout determines length of no flow time that the instrument will wait during a batch before raising a no flow error. It is also determines when an overflow error is raised if flow does not cease within the timeout period after the controller attempts to stop the flow. A value of zero disables these flow timeout features.</p> <p>Enter the value in seconds.</p>
COUNT DIR	<p>The batch count direction determines whether the batch total counts up from zero to the preset value or down from the preset to zero.</p> <p>Press <input type="button" value="▲"/> or <input type="button" value="▼"/> to select UP or DOWN.</p>
AUTO RESET	<p><i>This parameter is available for viewing and editing only when the batch automatic restart time is set to zero.</i></p> <p>The automatic reset feature allows the previous batch total to be reset automatically when a new batch is started with the RUN key.</p> <p>Press <input type="button" value="▲"/> or <input type="button" value="▼"/> to select ENABLE or DISABLE.</p>

SET ↓	▶ → UNITS PARAMS INPUTS OUTPUTS ALARMS COMMS TM/LOG SETUP TEST END
AUTO COMP	<p>The batch automatic overrun compensation allows the instrument to automatically compensate for any consistent overrun at the end of the batch. Overrun is typically due to the slowness of a valve to close or a pump to stop on receiving a signal from the batch controller and results in the delivered quantity being greater than the entered preset</p> <p>In calculating the amount to be compensated for the instrument uses the average overrun from the last three batches. An overrun of more than 20% is considered invalid and will not be included in the calculations.</p> <p>Press ▲ or ▼ to select ENABLE or DISABLE.</p>
No-SET BATCH	<p>To provide faster access to commonly used preset values a number of batch presets can be preprogrammed into the instrument. This parameter allows the number of batch presets to be entered.</p> <p>Press ▲ or ▼ to select a number between 1 and 10.</p>
SET-01 BATCH to SET-n	<p>Enter the commonly used preset values for quick access via the front panel.</p> <p>Enter the value in the engineering units of the batch preset.</p>
DIRECT ACCESS	<p>If the direct access is enabled then the operator is able to enter edit mode for the preset parameters (batch and flow) directly from the main menu by holding the SET key while viewing the preset. If disabled the presets can only be changed from within calibration set mode (or via serial communications, see below). Select the direct access mode as required.</p> <p>Press ▲ or ▼ to select ENABLE or DISABLE.</p>
PRESET SRC	<p>The instrument allows the batch and flow preset value to be changed via either of two methods:</p> <ul style="list-style-type: none"> • USER - The instrument allows the preset values to be changed only by the user via the front panel. • RTU - The instrument allows the preset values to be changed via Modbus RTU communications or by the user via the front panel. <p>Press ▲ or ▼ to select USER or RTU.</p>
P-CTRL SP	<p>Preset process control signal setpoint. This setpoint is only available for LOCAL control mode.</p> <p>Enter the value in the engineering units of the assigned variable.</p>
<p>If LOCAL control mode the live P-FLOW value is now shown to give immediate feedback without leaving calibration set mode.</p>	

SET ↓	▶ → UNITS PARAMS INPUTS OUTPUTS ALARMS COMMS TM/LOG SETUP TEST END
P-FLOW SP	Preset Loop/Process flowrate setpoint. This setpoint is only available for LOOP control and TUNE modes. The value of the setpoint must not be greater than the process flow range (P-FLOW RANGE).
If LOOP control or TUNE mode the live P-FLOW and DEVIATION values are now shown to give immediate feedback without leaving calibration set mode.	
PRESET BATCH	Enter the batch preset quantity. This setpoint is only available for PRESET batch mode. Enter the value in the engineering units of the assigned variable.







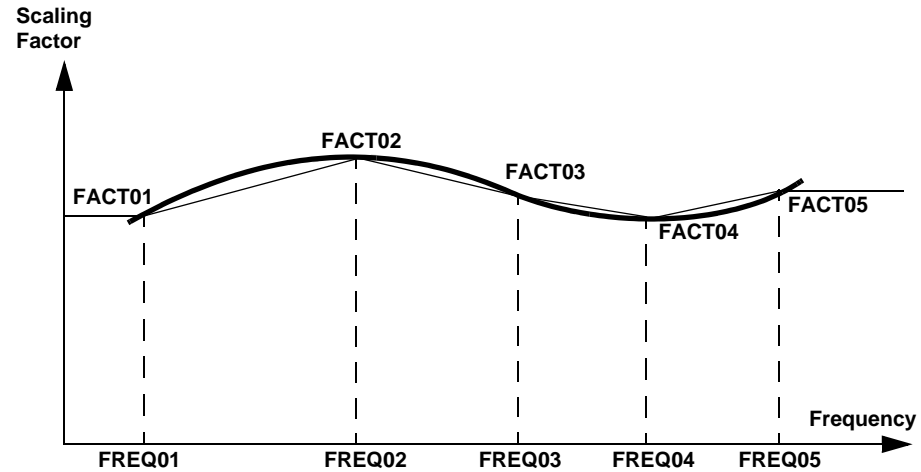

Inputs

SET ↓	▶ → UNITS PARAMS INPUTS OUTPUTS ALARMS COMMS TM/LOG SETUP TEST END
Frequency Input 1	
INPUT P-FLOW FINP1	For this application, Frequency Input Channel 1 is assigned to mass flowrate.
SIGNAL FINP1	Frequency input 1 signal type. Press ▲ or ▼ to select COIL, NPS or PULSE.
BUNCE FINP1	Switches and relays have metal contacts to make and break circuits. The contact bounce introduces random signals into the circuit. The instrument has a debounce circuit to eliminate this problem. Note: When the debounce circuit is enabled, the maximum input frequency for large amplitude signals is limited to approximately 500Hz. For low amplitude signals, the maximum frequency can be approximately 200Hz. Press ▲ or ▼ to select ENABLE or DISABLE.
CUTOFF FINP1	The Cut-off is the lowest frequency for which the instrument continues to calculate a rate from the flowmeter. The value for the cut-off is specified as the frequency of the flowmeter in Hertz. The default cut-off point is 0.25Hz. Be careful when setting cut-off values below 0.25Hz, because the display update time for the flow rate becomes very long. For example if the cut-off is set to 0.01Hz, and the measured flow stops, the instrument continues to display the flow rate for 100 seconds before it can determine that the flow has actually stopped.

SET ↓	▶ → UNITS PARAMS INPUTS OUTPUTS ALARMS COMMS TM/LOG SETUP TEST END																																													
FILTER FINP1	<p>Input fluctuations caused by pulsating flow tend to create distortion in the input readings of the rate. The instrument has a digital filter that averages out these fluctuations.</p> <p>As a guide to the degree of filtering to use, the following table shows the response time (in seconds) to reach 90% and 99% of a step change in input.</p> <p>The value A is the filter constant that the user can set.</p> <table border="1" style="width: 100%; border-collapse: collapse;"> <thead> <tr> <th style="width: 33%;">Filter setting A</th> <th style="width: 33%;">Seconds to reach 90% of full swing</th> <th style="width: 33%;">Seconds to reach 99% of full swing</th> </tr> </thead> <tbody> <tr><td>0</td><td>0</td><td>0</td></tr> <tr><td>2</td><td>2</td><td>4</td></tr> <tr><td>4</td><td>4</td><td>8</td></tr> <tr><td>6</td><td>5</td><td>10</td></tr> <tr><td>10</td><td>8</td><td>15</td></tr> <tr><td>15</td><td>12</td><td>23</td></tr> <tr><td>20</td><td>14</td><td>27</td></tr> <tr><td>25</td><td>18</td><td>34</td></tr> <tr><td>35</td><td>25</td><td>48</td></tr> <tr><td>45</td><td>32</td><td>62</td></tr> <tr><td>60</td><td>42</td><td>82</td></tr> <tr><td>75</td><td>52</td><td>102</td></tr> <tr><td>90</td><td>62</td><td>122</td></tr> <tr><td>99</td><td>68</td><td>134</td></tr> </tbody> </table> <p>The input filter range is from 0 to 99. A setting of 0 (zero) means that there is no filtering.</p>	Filter setting A	Seconds to reach 90% of full swing	Seconds to reach 99% of full swing	0	0	0	2	2	4	4	4	8	6	5	10	10	8	15	15	12	23	20	14	27	25	18	34	35	25	48	45	32	62	60	42	82	75	52	102	90	62	122	99	68	134
Filter setting A	Seconds to reach 90% of full swing	Seconds to reach 99% of full swing																																												
0	0	0																																												
2	2	4																																												
4	4	8																																												
6	5	10																																												
10	8	15																																												
15	12	23																																												
20	14	27																																												
25	18	34																																												
35	25	48																																												
45	32	62																																												
60	42	82																																												
75	52	102																																												
90	62	122																																												
99	68	134																																												
CORR FINP1	<p>If the input sensor has non-linear characteristics, select NON-LINEAR to apply correction factors to the input signal.</p> <p>Use ▲ or ▼ to select LINEAR or NON-LINEAR.</p>																																													
KFACT1 unit	<p><i>This parameter is available for viewing and editing only when the correction type is set to Linear.</i></p> <p>The K-factor of the flowmeter is the number of pulses from the flowmeter per unit of volume (or mass). The K-factor cannot be 0 (zero).</p>																																													

SET ↓	▶ → UNITS PARAMS INPUTS OUTPUTS ALARMS COMMS TM/LOG SETUP TEST END
NO-PTS FINP1	<p><i>This parameter is available for viewing and editing only when the correction type is set to Non-linear.</i></p> <p>Enter the number of non-linearity correction points.</p> <p>Press ▲ or ▼ to select a number between 1 and 10 for the number of correction points.</p>
FREQ01 FINP1 to FREQn	<p><i>This parameter is available for viewing and editing only when the correction type is set to Non-linear.</i></p> <p>Enter the frequency for this correction point.</p> <p>The instrument uses linear interpolation between the correction points except that the correction factor for FREQ01 is used from 0Hz up to FREQ01. Similarly, the instrument maintains the correction factor for the highest frequency setting up to the maximum input frequency.</p> <p>The following diagram shows the scaling factors at different frequencies for a hypothetical flowmeter. The heavy black line represents the actual scaling factor of the flowmeter. The light black line is the approximation that the instrument uses.</p>  <p>Enter the lowest correction factor frequency as FREQ01 and proceed up to the highest frequency. You can press the DISPLAY key to skip the non-linear points and go to the next item.</p>
FACT01 FINP1 to FACTn	<p><i>This parameter is available for viewing and editing only when the correction type is set to Non-linear.</i></p> <p>Enter the scaling factor for this correction point.</p> <p>The correction factor cannot be 0 (zero).</p>

Outputs

		 → UNITS PARAMS INPUTS OUTPUTS ALARMS COMMS TM/LOG SETUP TEST END
<p>Note: In the factory default version of this application output channel 1 (OUT 1) is dedicated as the 4-20mA Process Control signal. Output channel 2 can be freely configured.</p>		
FUNC OUT _n		<p>The output can function as either a pulse output for retransmission of totals, a no flow error signal, a pump control output or an end of batch signal. (Note: there is no End of batch signal if Batch mode is On-Off).</p> <p>Press  or  to select RETRANS, OP-ERR, OP-CTRL or OP-END</p>
PULSE or 4-20	OUT _n	<p>You can assign any of the “main menu” variables to an output. The nature of the output depends on the assigned variable. Totals are output as pulses and rates are output as 4-20mA passive signals.</p> <p>Press  or  to select the variable that is required as an output. The top of the display shows the type of output signal that is assigned to the variable.</p> <p style="text-align: center;">CAUTION</p> <p style="text-align: center;">Due to the dual-purpose nature of the outputs, take care not to set the output as an open collector pulse type signal when connected to a 4-20mA loop circuit.</p>
WIDTH	OUT _n	<p><i>The Output Pulse Width is available for viewing and editing only when the assigned variable is a total (pulse output) type.</i></p> <p>Pulse output is usually used to drive remote counters. Set the pulse width (in milliseconds) as required by the remote counter.</p> <p>Press  or  to set to: 10, 20, 50, 100, 200 or 500ms.</p>
PULSE	OUT _n	<p><i>The Output Pulse Factor is available for viewing and editing only when the assigned variable is a total (pulse output) type.</i></p> <p>The Output Pulse Factor is the scaling factor for the retransmission of the measured total quantity.</p> <p>For example, if “volume” is chosen as an output variable, the engineering unit is cubic metres. Therefore a pulse factor of 1.000 generates one pulse for 1 m³. Similarly, a pulse factor of 3.000 generates one pulse for 3 m³.</p> <p>For more information, see Output Pulse Factor on page 43.</p> <p>The output pulse factor cannot be 0 (zero).</p>

SET ↓	▶ → UNITS PARAMS INPUTS OUTPUTS ALARMS COMMS TM/LOG SETUP TEST END
PT--MIN PT--MAX	<p style="text-align: right;">OUT_n OUT_n</p> <p><i>The Output Minimum Point and Maximum Point are available for viewing and editing only when the assigned variable is a rate (4-20mA output) type.</i></p> <p>The output minimum value corresponds to the 4 mA point and the output maximum value corresponds to the 20mA point.</p> <p>Setting the output range differently from the input range enables the instrument to amplify the input signal. You can drive a chart recorder that “zooms in” on a specified range of values instead of displaying the full operating range of the transducer.</p> <p>For example, if the minimum point is set to 30m³/min and the maximum point is set to 100m³/min, the 4 to 20mA range would reflect the volumetric flow rate range of 30 to 100m³/min. At rates above the maximum and below the minimum points, the output remains at 20mA and 4mA respectively.</p>

Output Pulse Factor

Increasing the output pulse width reduces the maximum frequency at which a total variable can be retransmitted. Pulses will be missed if the output cannot “keep up” with the rate of total counts. You can use the output pulse factor to ensure that this maximum is not reached.

The maximum pulse output frequency is determined by:

$$\frac{1000}{(2 \times \text{pulse width in ms})} \text{ Hz}$$

The minimum pulse factor required is determined by:

$$\frac{\text{max rate of total}}{\text{max pulse output frequency}}$$

For example: To calculate the required pulse factor to avoid losing counts in retransmission if a total counts at a maximum rate of 75 units/sec (Hz) and the required pulse width of a remote counter is at least 50ms:

The maximum pulse output frequency is: $\frac{1000}{2 \times 50} = 10\text{Hz}$

The minimum pulse factor for that frequency is: $\frac{75}{10} = 7.5$

Alarms



There are two alarm relays, in the advanced option, that can be assigned to rate variables such as volume flowrate, or set as an equipment failure alarm.

The alarm switches “on” whenever an alarm condition exists. The alarm switches “off” when the alarm condition no longer exists. However, you may need to configure external alarm devices that require acknowledgement for cancelling an alarm.

Equipment Failure Alarm

Any alarm relay can be assigned as an equipment failure alarm. This alarm setting has normally closed contacts that open when the instrument displays any error message as listed in [Error Messages](#) on page 52, or if there is a loss of power to the instrument.

<input type="button" value="SET"/> ↓	<input type="button" value="▶"/> → UNITS PARAMS INPUTS OUTPUTS ALARMS COMMS TM/LOG SETUP TEST END
RELAY ALRM _n	<p>Select a rate variable to assign to the alarm relay.</p> <p>Note: If the alarm type is set to “equipment alarm”, this relay assignment setting is ignored.</p> <p>Press <input type="button" value="▲"/> or <input type="button" value="▼"/> to select the variable that is required as an alarm.</p>
TYPE ALRM _n	<p>The options available for alarm types are as follows:</p> <ul style="list-style-type: none"> • HI-NO — High Alarm, Normally Open contacts • HI-NC — High Alarm, Normally Closed contacts • LO-NO — Low Alarm, Normally Open contacts • LO-NC — Low Alarm, Normally Closed contacts • AL-NC — Equipment Alarm, Normally Closed contacts <p>Press <input type="button" value="▲"/> or <input type="button" value="▼"/> to select the type of alarm required.</p>
POINT ALRM _n	<p><i>The Alarm Setpoint is available for viewing and editing only when the alarm type is a high or low alarm.</i></p> <p>The Alarm Setpoint is the value (in engineering units of assigned variable) at which the alarm condition occurs and therefore the alarm is on.</p> <p>Each alarm is completely independent, e.g. a High alarm does NOT need to have a higher setpoint than the a Low alarm.</p>

 ↓	 → UNITS PARAMS INPUTS OUTPUTS ALARMS COMMS TM/LOG SETUP TEST END
HYST ALRMn	<p><i>The Alarm Hysteresis is available for viewing and editing only when the alarm type is a high or low alarm.</i></p> <p>Alarm hysteresis loops occur when the alarm toggles continuously on and off when the process variable is close to the setpoint.</p> <p>For a high alarm, the alarm activates when the value of the variable rises above the alarm setpoint and deactivates when the value falls below the alarm setpoint minus the amount of the hysteresis setting (if any). For a low alarm, the alarm activates when the value of the variable falls below the alarm setpoint and deactivates when the value rises above the alarm setpoint plus the amount of the hysteresis setting (if any).</p> <p>For example, with a high alarm setpoint of 200, and a hysteresis setting of zero, a value oscillating between 197 and 202 will cause the alarm to toggle on at 200 and toggle off below 200. However, if the hysteresis is set to 5, the value of the variable must fall below 195 to cancel the alarm. The alarm will reactivate only when the value again rises above 200.</p>
DELAY ALRMn	<p><i>The Alarm Delay is available for viewing and editing only when the alarm type is a high or low alarm.</i></p> <p>The Alarm Delay is programmed in seconds and can be used to eliminate undesired alarm activation during start-up or shutdown operation.</p>

Communications

The instrument has three communication ports:

- **RS-232 Port** - A 9-pin female connector on the rear panel of the instrument.
- **Infra-red Port** - Located on the front panel, below the status indicators.
- **RS-485 Port** - (Advanced option only) Terminals on the rear panel.

SET ↓		▶ → UNITS PARAMS INPUTS OUPUTS ALARMS COMMS <small>TM/LOG SETUP TEST END</small>
PROTOC RS232 RS485 INFRA		<p>The Communications Protocol for each communication port can be set to either ASCII or Modbus RTU. A protocol cannot be assigned to more than one port at a time. If a port is not being used, set the protocol to NONE.</p> <p>If the Real Time Clock option installed the RS232 port can also be assigned the printer protocol (PRN).</p> <p>For the selected port, press ▲ or ▼ to select NONE, RTU, ASCII or PRN (RS232 only).</p>
BAUD RS232 RS485 INFRA		<p>The Baud setting is the speed of the communication port in data bits per second.</p> <p>The baud rate of the instrument must match the baud rate of the communication device that the instrument is connected to.</p> <p>Use ▲ or ▼ to select 2400, 4800, 9600 or 19200 baud.</p>
PARITY RS232 RS485 INFRA		<p>The Parity bit offers a small amount of error checking, to help detect data corruption that might occur during transmission.</p> <p>The parity bit setting of the instrument must match the parity bit checking of the communication device that the instrument is connected to.</p> <p>Press ▲ or ▼ to select EVEN, ODD, or NONE.</p>
S-BITS RS232 RS485 INFRA		<p>The Stop bit indicates the end of a transmission. Stop bits can be 1 or 2 bit periods in length. The stop bit setting of the instrument must match the stop bit setting of the communication device that the instrument is connected to.</p> <p>Press ▲ or ▼ to select 1 or 2 stop bits.</p>
RTU ADDR		<p>The Modbus RTU protocol address must be in the range of 1 to 247. When multiple instruments (slaves) are connected to one communication device (master), each assigned address must be unique.</p> <p>Note: The master device uses the RTU address 0 (zero) for broadcasting to all connected slave units.</p>

<input type="button" value="SET"/> ↓	<input type="button" value="▶"/> → UNITS PARAMS INPUTS OUPUTS ALARMS COMMS <small>TM/LOG SETUP TEST END</small>
ASCII ADDR	<p>The ASCII protocol address identifies each communicating device.</p> <p>The address must be in the range of 1 to 255. When multiple instruments (slaves) are connected to one computer (master), each assigned address must be unique.</p>
FLASH PORT	<p>The Flash Driver Port assignment defines the communication port for downloading software into the instrument.</p> <p>The default setting of this assignment is the RS-232 port.</p> <p>Press <input type="button" value="▲"/> or <input type="button" value="▼"/> to select RS-232, RS-485, or INFRA.</p>

Time Settings and Data Logging

Instrument Clock

Note: The real-time clock is part of the advanced option package.

The instrument has a real-time clock for recording logged events. The clock displays the time and the date. The date format can be set to European format (day/month/year) or American format (month/day/year). The time clock uses the 24-hour format.

The clock will continue to operate for up to 5 years (typically) on the internal battery if there is no power connected to the instrument. Therefore, after an interruption to the power supply, the instrument recommences normal operation although there will be no data recorded during the period without a power supply.

Note: If there is an interruption to the power supply and the battery has failed, the instrument displays an error message when the power supply is restored. In this case, you should set the current time and date so that the instrument continues to log data at the correct times.

Data Logging

The instrument will log a total of 1000 deliveries (batches) if the real-time clock option is installed. The logs are taken at the end of each batch or upon reset if a batch has been aborted before the preset total has been reached.

SET ↓		▶ → UNITS PARAMS INPUTS OUPUTS ALARMS COMMS TM/LOG SETUP TEST END
DATE	FORM	<p>Clock Date Format</p> <p>The European date format is: dd/mm/yyyy or (Day-Month).</p> <p>The American date format is: mm/dd/yyyy or (Month-Day).</p> <p>Press ▲ or ▼ to select DAY-M or M-DAY</p>
CLOCK	YEAR	The Clock Year defines the current year for the real-time clock.
CLOCK	M-DAY	The Clock M-DAY setting defines the current month and date for the real-time clock. This parameter is programmed in Month-Day format for both European and American date formats.
CLOCK	H-MIN	The Clock H-MIN setting is the current time in hours and minutes for the real-time clock.
RESET	LOGS	<p>Reset the logged data. You may need to reset (clear) the logged data if you change the time/log settings.</p> <p>Press ▲ or ▼ to select YES, then press the SET key. The instrument makes three beeps to confirm the reset command.</p>
REPORT	LOGS	<p>The Printer Protocol Report Logs defines the number of latest logs to be included into a printable report.</p> <p>Enter the number of logs between 0 and 99.</p>
REPORT	TYPE	<p>The Printer Protocol Report Type determines the nature of the printout from the REPORT PRINT - HOLD.SET prompt in the main menu. The following report types available in this instrument are:</p> <ul style="list-style-type: none"> • REP-10 Preset number of latest logs <p>Press ▲ or ▼ to select Report Type.</p>
PRN	TYPE	<p>The Printer Protocol Printer Type allows the nature of the printer being used to be specified. The following printer types available in this instrument are:</p> <ul style="list-style-type: none"> • PRN-01 Generic computer printer • PRN-02 Generic roll printer (prints first line first) • PRN-03 Slip printer TM295 <p>Press ▲ or ▼ to select Printer Type.</p>

General Setup Parameters

SET ↓	▶ → UNITS INPUTS OUPUTS ALARMS COMMS TM/LOG SETUP TEST END
DEFAULT VAR	<p>Select the main menu variable to display on power up or when the display timeout period has elapsed if it is enabled.</p> <p>Press ▲ or ▼ to select the default variable display.</p>
SUPPLY VOLT	<p>The instrument provides a power-limited supply for external transducers.</p> <p>Press ▲ or ▼ to set the transducer supply voltage between 8 and 24 volts DC as required.</p>
T-OUT MODE	<p>If the Display Timeout mode is enabled, and there is no user activity for the defined timeout period, the display panel returns to the default display.</p> <p>This function is useful for the following reasons:</p> <ul style="list-style-type: none"> • to return the display to a preferred variable after the user has finished reading other information, • to cancel the calibration mode and return to the default display if the user does not exit from the calibration mode for any reason. <p>Press ▲ or ▼ to select the display timeout function as follows:</p> <ul style="list-style-type: none"> • DISABLE - Timeout is completely disabled. • EN DISP - Timeout is enabled during Normal mode and Calibration View mode. • EN EDIT - Timeout is enabled during Calibration Set mode. • EN ALL - Timeout is enabled for all modes.
T-OUT SEC	<p>The Display Timeout period defines the delay for the Display Timeout mode if it is enabled.</p> <p>The display timeout period can be from 10 to 99 seconds.</p>
RESET ACCUM	<p>The Reset Accumulated Totals function clears all of the accumulated totals and the non-accumulated totals.</p> <p>Press ▲ or ▼ to select YES, then press the SET key. The instrument makes three beeps to confirm the reset command.</p>

SET ↓	▶ → UNITS INPUTS OUPUTS ALARMS COMMS TM/LOG SETUP TEST END
DISPL TAGS	<p>The Display Tags option determines whether the instrument displays the default display tags or the user-defined tags. The display tag setting also defines whether the instrument displays the default error and warning messages, or the user-defined messages.</p> <p>Note: The user-defined tags can be entered into the instrument only by the manufacturer or the distributor.</p> <p>Press ▲ or ▼ to select the Display Tags option as follows:</p> <ul style="list-style-type: none"> • DEFAULT - the instrument displays the default (English) tags • USER - the instrument displays the user-defined tags.
BACK-L T-OUT	<p>If the backlight timeout is enabled, and there is no user activity (any keys pressed) for a period of 10 seconds, the display backlight switches off to save power. The backlight switches on when a key is pressed. Select the backlight timeout mode as required.</p> <p>Press ▲ or ▼ to select ENABLE or DISABLE.</p>

Test Menu

The Test menu enables you to view the inputs and outputs to and from the instrument.

In Calibration Set mode, (by entering the system password) you can control the outputs and the alarms as described in the table below.

SET ↓	▶ → UNITS PARAMS INPUTS OUPUTS ALARMS COMMS TM/LOG SETUP TEST END
FINP1 Hz	The frequency of the input to FINP1 is displayed in Hertz.
AINP1 to AINP4 units	The units are displayed according to the calibration setup for this analog input. If unused or set to Default the input is 4-20mA and displayed in mA.
LINP1 STATE to LINP4	You can view the state of the logic inputs. If the input is an open contact or inactive it will display HI . If the input is a closed contact or active it will display LO .

SET ↓	▶ → UNITS PARAMS INPUTS OUPUTS ALARMS COMMS TM/LOG SETUP TEST END
OUT1 STATE to OUT2	<p>You can control the state of the outputs. Press the ▲ or ▼ keys to set the output state as follows:</p> <ul style="list-style-type: none"> • PROCESS - the output depends on the current values of the inputs and the calculations that the instrument performs. <p>For a pulse output, such as a total, the output produces a pulse train as follows:</p> <ul style="list-style-type: none"> • ON - a pulse train with a pulse width as set for the particular output in the Outputs menu. • OFF - no output. <p>For a 4-20mA output, such as a rate, the output is as follows:</p> <ul style="list-style-type: none"> • HI - the output is set to 20mA. • LO - the output is set to 4mA.
REL-1 STATE to REL-2	<p>You can control the state of the relays. Press the ▲ or ▼ keys to set the selected relay as follows:</p> <ul style="list-style-type: none"> • PROCESS - the relay condition operates according to the current batch status and the relay settings as programmed. • OPEN - the relay output contacts are set to “open”. • CLOSED - the relay output contacts are set to “closed”.
ALRM3 STATE to ALRM4	<p>You can control the state of the alarms. Press the ▲ or ▼ keys to set the selected alarm as follows:</p> <ul style="list-style-type: none"> • PROCESS - the alarm condition operates according to the current values of the inputs and the alarm settings as programmed. • OPEN - the alarm output contacts are set to “open”. • CLOSED - the alarm output contacts are set to “closed”.
SUPPLY ✓	<p>You can display the actual DC output supply voltage, which may help with troubleshooting.</p> <p>If the actual supply voltage is lower than the preset value (refer to General Setup Parameters on page 49) it may indicate that the output is overloaded.</p>

System Messages

The instrument displays messages for defined events and fault conditions.

The manufacturer or distributor can enter user-defined text for the messages. This user-defined text is displayed, instead of the default (English) messages, when the Display Tags option in the Setup menu is set to USER.

Error Messages

The system displays error messages as described in the following table:

Error Messages	Description
CPU Card Failure	There are failed components on the CPU card and technical support is required.
Power Supply is Low	The input and/or output power supply voltage is too low, ensure that: (a) input power supply voltage is within the specified range (b) output power supply is not overloaded.
New/Failed Battery - Set Time	The real-time clock has lost the correct time because the battery has failed, or there is a new battery. Set the current time and date (in the TM/LOG menu) to clear the error message and to continue data logging at the correct times. Note: The instrument can continue operating with a failed battery, but the correct time will be lost if there are interruptions to the power supply.
No Flow Detected	The no flow condition is detected when the flow timeout expires during a delivery. There must not be a period of no flow greater than the timeout value during the delivery.
Overflow Detected	The overflow condition is detected when the flow continues longer than the timeout period after the controller has attempted to stop the flow.
Leakage Detected	The leakage condition is detected when an amount greater than the acceptable total is received without flow being initiated by the batch controller.

Warning Messages

The system displays warning messages as described in the following table:

Warning Messages	Description
Value Has Been Set to Default	You have entered an invalid value for a parameter. Therefore, the instrument has set the default value.
Already Assigned to Other Port	You have tried to assign a particular protocol type to more than one serial communication port. The instrument has set the protocol to NONE.
Preset Over Limit - Max Set	You have exceeded the preset limit. The instrument will set the maximum allowed value.

Chapter 6

Communications

Overview

This chapter describes the communications between the instrument and another communicating device such as a computer or a printer. You should have relevant information about the devices to which the instrument will be connected. Some connection examples are included in this manual, however, the operation and connection of other devices is outside the scope of this manual.

Hardware Interconnection

The instrument has three communication ports:

- RS-232 port on the rear panel (DB9 female connector)
- RS-485 port on the rear panel (advanced option only)
- Infra-red port on the front panel

The appropriate interface and protocols are selected during calibration.

RS-232 Port

The RS-232 port provides communication between the instrument and one other device such as a host computer or a printer.

Note: A printer must have a serial port to be able to be directly connected to the flow computer. It is not possible to communicate directly with a printer via a parallel port.

Computers use either a DB9 or a DB25 connector, and the connections to each type are shown in Figure 11.

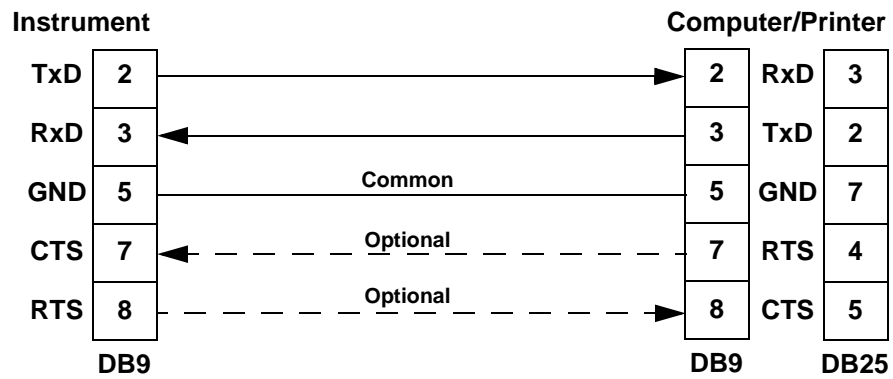

Figure 11 RS-232 Cable Connections to a Computer

Note: The instrument requires a cable with straight-through connections. Do not use a null modem cable for RS-232 connection to a computer.

RS-485 Port (Advanced Option only)

The RS-485 port enables communication with multiple devices. Each device has a unique address so that the “master” device can communicate with specific “slave” devices.

On RS-485 links, an external terminating resistor must be connected at the furthest end of the cable. When multiple instruments are connected, they should be “daisy chained” in a multidrop configuration as shown in Figure 12. Up to 32 units can be connected to the interface at a maximum distance of 1200 metres.

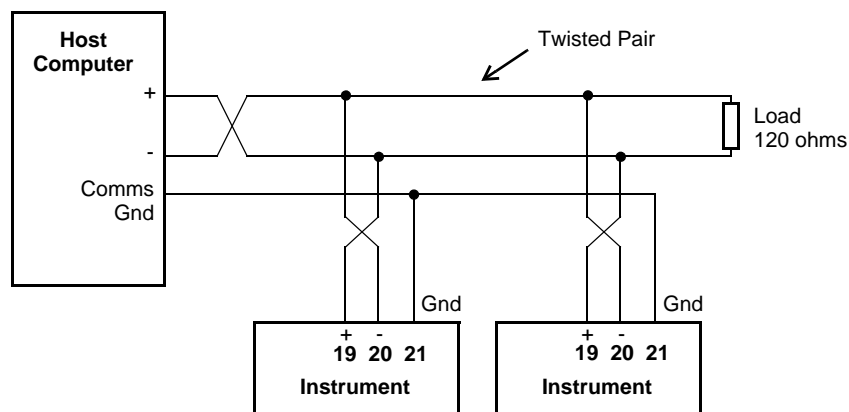

Figure 12 RS-485 Connections

Infra-red Port

The infra-red port is located on the front panel of the instrument. The infra-red port uses the Infra-red Developers Association (IrDA) physical layer format of signal encoding and decoding.

The nature of the infra-red port requires the communicating device to be located close to the front of the instrument. Therefore, its main use would probably be for reloading the instrument application software, or occasional collection of data, rather than continuous communications.

Protocols

Note: ASCII and Printer protocols are only available in the “Standard” 515 CPU card, identified on the model number by: 515.xx1xxx-xxxx

Any of the ports on the instrument can use the ASCII or Modbus RTU communication protocols. The RS232 port can also be assigned the Printer Protocol.

- **ASCII** - In this ASCII protocol each command and response is a string of ASCII characters. This proprietary protocol is developed by Contrec to allow for simple information interchange. The main advantages of this mode are that it allows extended time intervals to occur between characters without causing a timeout error and that messages can be sent and monitored easily with a simple ASCII terminal.
- **Modbus RTU** - Modbus RTU is an industry-standard protocol which allows the instrument to be easily connected to computers running supervisory software systems. The main advantage of this mode is that its greater character density allows better data throughput than ASCII mode, however each message must be transmitted in a continuous stream.
- **Printer** - In the Printer protocol there is a selection of printer types. Please refer to the [Printer Protocol](#) on page 67 for full details.

Note: If a port is not being used, its protocol should be set to NONE in the instrument configuration as described in [Communications](#) on page 45.

A protocol cannot be assigned to more than one port. Therefore if you assign Modbus RTU protocol to the RS-485 port, you cannot assign it to the RS-232 port also. The RS-232 port can now only use the ASCII or Printer protocol or NONE.

Simple ASCII Protocol

Note: Not all ASCII commands are applicable for Batch Controller applications.

This simple ASCII protocol requires that all requests are initiated with a colon (:) and terminated with a carriage return (C_R). The message termination can include a linefeed before the carriage-return ($L_F C_R$), but it is the carriage-return that acts as the message termination.

All responses by the instrument are terminated with a linefeed and a carriage-return ($\text{L}_\text{F}\text{C}_\text{R}$).

Requests Format

The format of a request to the instrument is as follows:

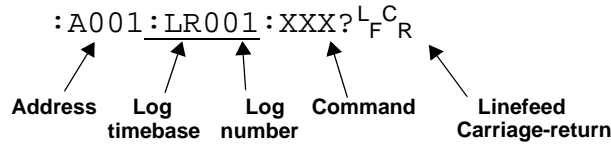

Each request must include the address and command portions. The underlined section is an optional part of the request string.

Address

In multipoint communications, each instrument must have a unique address and it is essential in the request for identifying a particular instrument. However, it may be set to 000, for special broadcast commands. For single-instrument communications, the address can also be set to 000 in the request.

Refer to [Communications](#) on page 45 for setting the instrument address.

Note: The instrument always responds with its address in the header regardless of the type of request.

Log Type and Number

The log type and number enables a communicating device to retrieve data from the instrument. The data can be from the event-based logs or from the current process variables with the either accumulated or non-accumulated (resettable) totals.

The log request is optional. If the log request is not included, or the log number is set to 000, the instrument returns the current process variables. If the log request is included, the log number defines the specific log entry by counting backwards. The most recent log entry for a timebase is 001.

The “last edit” log records the process variables at the time of the last exit from the calibration edit mode. There is only one “last edit” log, therefore, if a number is included in the request, the instrument ignores the number and returns the data at the time of the last edit. Likewise, there is only one set of current process variables with “non-accumulated totals”, therefore it also ignores any log number included in that request.

The types of the logs applicable to this instrument are as follows:

Log Type
LE - last edit log
LR - logged records (non-timebased logging)
LN - current totals displayed as Non-accumulated

The number of the log entry is the same as shown on the front panel of the instrument. For example, a request for LR003 would return the data for the log entry two batches prior to the most recent batch log entry.

Instrument Responses

The instrument response time to any enquiry is not more than 300ms. The responses from the instrument are in the following format:

```

HEADERLFCR
DATALFCR
DATALFCR
.
.
.
DATALFCR
LFCR
    
```

The components of the response message are as follows:

Header

The format of the response header from the instrument is as follows:

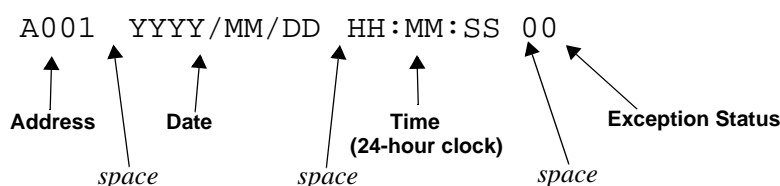

The instrument **Exception Status** codes that the instrument returns for the ASCII protocol are the same as those described for the Modbus RTU protocol in [Instrument Exception Status](#) on page 64.

Data

The format of the data variables from the instrument is as follows:

8 9 1 2 3 . 4 5 6											M 3							V O L U M E										
1	2	3	4	5	6	7	8	9	10	11	12	13	14	15	16	17	18	19	20	22	23	24	25	26	27			
Value (aligned right)											<i>space</i>	Unit (aligned left)							<i>space</i>	Item (aligned left)								

Note: The decimal point in the Value is always at character position 8. Therefore whole numbers are aligned right at the decimal point, with trailing zeroes.

Variables Request

The variables request asks the instrument to return the value of one or more requested variables. All totals are transmitted as accumulated totals.

Command	Description
:RVA?	Return all variables
:RVD?	Return the default Total and Rate
:RV0? ... :RV9?	Return the specific variable. The numbers relate to the position in the variables menu. For example, V0 is Energy, V1 is Power and so on.

Variables Request and Response Example

The following request is for the only instrument that is connected to the communication port to return the values of all main menu variables.

: A 0 0 1 : R V A ? L_F C_R

The following is an example of a hypothetical instrument response. Refer to [Main Menu Variables](#) on page 2 for the list of variables that would be returned for this application.

```

A 0 0 1   2 0 0 2 / 0 3 / 1 4   1 8 : 2 5 : 0 0   0 0 LF CR
          6 . 1 1 6   M W h           E N E R G Y   LF CR
          1 6 . 5 7 3   M W           P O W E R     LF CR
    1 3 2 0 . 5 3 0   m 3           V O L U M E   LF CR
          5 8 . 3 0 0   m 3 / M       V - F L O W   LF CR
    7 6 2 7 . 1 1 7   K G           M A S S       LF CR
          3 4 4 . 4 6 0   K G / M     M - F L O W   LF CR
          2 3 0 . 0 0 0   D E G   C   T E M P     LF CR
          1 . 2 6 0   M P A           P R E S S   LF CR
          0 . 1 7 4   m 3 / K G       S P - V O L   LF CR
    2 8 8 6 . 7 6 0   K J / K G       S P - E N T   LF CR
LF CR
    
```

The following message to an instrument, requests the current values for the default rate and total:

: A 0 0 1 : R V D ? L_F C_R

The instrument response would be similar to the following:

```
A 0 0 1 2 0 0 2 / 0 3 / 1 4 1 8 : 2 5 : 0 0 0 0 LF CR
      1 2 6 . 4 5 5 m 3 V O L U M E LF CR
      2 0 . 4 3 7 m 3 / M V - F L O W LF CR
LF CR
```

Log Request

The log request asks the instrument how many logs will be included in a printed log report. These are the values described in [Time Settings and Data Logging](#) on page 47.

Command	Description
:RLR?	Return the number of log records (non- timebased logging)

Log Response Example

The following message asks the instrument with address 001 to return the number of hourly logs that the instrument stores:

```
: A 0 0 1 : R L R ? LF CR
```

The instrument response would be similar to the following:

```
A 0 0 1 2 0 0 2 / 0 3 / 1 4 1 8 : 2 5 : 0 0 0 0 LF CR
2 4 LF CR
LF CR
```

Clear Data Request

The clear data request asks the instrument to clear the data in the selected registers.

Command	Description
:RCN?	Clear the non-accumulated (resettable) totals
:RCA?	Clear the accumulated totals
:RCL?	Clear the logs except for the “last edited” log

Clear Data Request Example

The following message asks the instrument with address 001 to clear the logged data that the instrument stores:

```
: A 0 0 1 : R C L ? LF CR
```

The instrument response would be similar to the following:

```
A 0 0 1 2 0 0 2 / 0 3 / 1 4 1 8 : 2 5 : 0 0 0 0 LF CR
LF CR
```

Instrument Information Request

The Instrument Information request asks the instrument to return the general information about the model and version codes. The instrument exception status is returned as a part of the header as it is with the header for all command responses.

Command	Description
:RIG?	Return the general information about the instrument such as Model number, Application number, Version and Serial numbers etc. These items are returned as a block in the same format as shown on the display in the “Model Info” menu.

Instrument Information Response Example

The following message asks the instrument with address 001 to return the general information about the instrument:

```
: A 0 0 1 : R I G ? LF CR
```

The following is an example of a hypothetical instrument response:

```
A 0 0 1 2 0 0 2 / 0 3 / 1 4 1 8 : 2 5 : 0 0 0 0 LF CR
5 1 5 M O D E L - 1 1 - F - LF CR
S C 0 1 I N P U T F - T P - - LF CR
S C 0 1 V E R S 0 1 0 1 . 0 0 1 LF CR
C U S T O M V E R S 0 0 0 0 0 1 LF CR
U N I T S / N 1 2 3 4 5 6 LF CR
LF CR
```

1	2	3	4	5	6	7	8	9	10	11	12	13	14	15	16	17	18	19	20	21	22	23	24	25	26	27	28	29
---	---	---	---	---	---	---	---	---	----	----	----	----	----	----	----	----	----	----	----	----	----	----	----	----	----	----	----	----

Corrupted or Invalid Requests

If the instrument receives a corrupted or incomplete request, there is no response. The instrument discards any partial request and waits for the next enquiry.

If the instrument receives a request message in the correct format, but for a non-existent option, it returns only the message header. For example, if the instrument received the following request variables message :A001:RVT? it will return only the header because there is no T option for the ‘Variables Request’ message.

Modbus RTU Protocol

Modbus RTU (remote terminal unit) is an industry standard protocol that allows the instrument to be easily interfaced to other communication devices.

The instrument implements the Modbus protocol as detailed in the *Modicon Modbus Protocol Reference Guide* PI-MBUS-300 Rev J (June 1996).

Message Format

In RTU mode, messages start with a silent interval of at least 3.5 character times. The first field transmitted is the device address. Following the last transmitted character, a similar interval of at least 3.5 character times marks the end of the message. A new message can begin after this interval. The entire message frame must be transmitted as a continuous stream. A typical message frame is shown below:

Address	Function	Data	CRC Check
1 byte	1 byte	n bytes	2 bytes

Except for broadcast messages, when a master device sends a query to a slave device, it expects a normal response. One of four possible events can occur from the master's query:

- If the slave device receives the query without a communication error, and can handle the query normally, it returns a normal response.
- If the slave does not receive the query due to a communication error, no response is returned. The master program has to process a timeout condition for the query.
- If the slave receives the query, but detects a communications error (parity or CRC), no response is returned. The master program has to process a timeout condition for the query.
- If the slave receives the query without a communication error, but cannot handle it (for example, if the request is to read a nonexistent register), the slave will return an exception response informing the master of the nature of the error.

Instrument Address

The address of the instrument is programmable in the range from 1 to 247. Some addresses are reserved according to PI-MBUS-300 and have a special meaning:

- 0 = Broadcast, no response required from slave devices
- 248 to 255 Reserved

Function Codes

The instrument accepts the following function codes:

Code	Name	Description
03	Read data register(s)	Obtain the content of one or more 2-byte data registers.
06	Preset data register	Preset one 2-byte data register.
07	Read status register	Obtain the content of 1-byte status register.
16	Preset data register(s)	Preset one or more 2-byte data registers.

Exception Response

The instrument forms an exception response by adding 80H to the function code and using an exception code as the 1-byte data field in the returned frame. Implemented exception codes are as follows:

Code	Name	Description
01	Illegal function	The function code is not a legal action for the slave.
02	Illegal data address	The data address is not a legal address for the slave.
03	Illegal data value	The data value is not a legal value for the slave.
05	Acknowledge	The slave has accepted the request and is processing it, but a long duration of time will be required to do so.
06	Slave device busy	The slave is engaged in processing a long duration program command. The master should re-transmit the message later when the slave is free.

List of Data Registers

The following list describes the addresses and meaning of the data registers in the instrument. The floating point values are expressed in the engineering units that were selected for the variables when the instrument software was downloaded.

The registers are grouped in blocks that relate to a particular function of the instrument.

Note: Conventional numbering of registers often starts from 1, therefore be aware that “register 1” in this case has “address 0” and so on.

Current and Logged Process Data

This block of registers is available for the retrieval of current or logged process data with its matching time and date information.

Use the log timebase and log number to retrieve the logged information from the appropriate register. If a particular log number does not exist, or the instrument does not have the optional real-time clock, the time and date stamp and associated variables are set to zero.

Register	Name	Comments	Read Only or Read/Write	Type
1	Mass	<p style="text-align: center;">Process Variables</p> <p>By default totals are the Accumulated values. If current Non-accumulated (resettable) totals are required, set register 37 to 06. All logged totals are the Accumulated values.</p>	R	FP*
3	Reserved		R	FP
5	Reserved		R	FP
7	Reserved		R	FP
9	Reserved		R	FP
11	Reserved		R	FP
13	Reserved		R	FP
15	Reserved		R	FP
17	Reserved		R	FP
19	Reserved		R	FP
21	Reserved		R	FP
23	Reserved		R	FP
25	Reserved		R	FP
27	Reserved		R	FP
29	Reserved		R	FP
31	Year	<p>Current Date/Time or Logged Date/Time Stamp (see register 38 Log Number). Only current Date/Time can be edited</p>	R/W	I†
32	Month		R/W	I
33	Date		R/W	I
34	Hour		R/W	I
35	Minute		R/W	I
36	Second		R	I
37	Log Type	<p>00 - hourly or log records 01 - daily 02 - weekly 03 - monthly 04 - yearly 05 - last edit of calibration 06 - current totals are non-accumulated values, register 38 is ignored.</p>	R/W	I
38	Log Number	If set to 0, current variables and Date/Time are retrieved	R/W	I

Register	Name	Comments	Read Only or Read/Write	Type
39	Clear Data	01 - clear logs 02 - clear accumulated totals 03 - clear non-accumulated totals	W	
40	Reserved		R/W	

* FP = Floating Point (2 registers = 4 bytes)

† I = Integer (2 bytes) (Holding Registers)

Note: The Floating Point variable is represented in IEEE-754 Floating Point 4-byte format and requires two 2-byte data registers:

IEEE-754	Modicon Registers
1st byte	low byte (register X)
2nd byte	high byte (register X)
3rd byte	low byte (register X+1)
4th byte	high byte (register X+1)

This means that two data registers must be read or written to obtain, or preset, one data value.

Instrument Exception Status

This register is available to verify the status of the instrument.

Register	Name	Comments	Read Only or Read/Write	Type
41	Exception Status	00 = no error 01 = analog input 1 failure 02 = analog input 2 failure 03 = analog input 3 failure 04 = analog input 4 failure 05 = invalid calibration parameter 06 = invalid reference parameter 07 = invalid property 08 to 09 reserved 10 = process parameters out of range 11 = input is over limit 12 = no flow error detected 13 = overflow error detected 14 = leakage error detected 20 = system failure 21 = power supply is low 22 = new or failed clock battery	R	I*

* I = Integer (2 bytes) (Holding Registers)

Instrument Configuration, Control and I/O

This block of registers is available in some applications to give access to important information in the instrument.

Register	Name	Comments	Read Only or Read/Write	Type
42	Parameter Source	0 = User 1 = Modbus	R	I*
43	Logic Inputs	0 to 15 Binary representation of logic inputs B0 = 0/1 (LSB) input 1 activated/deactivated B1 = 0/1 input 2 activated/deactivated B2 = 0/1 input 3 activated/deactivated B3 = 0/1 input 4 activated/deactivated	R	I
44	Operation State	Representation of operation status 0 = Reset 1 = Maintenance 2 = Completed 3 = Waiting to restart 4 = Paused 5 = Waiting for timeout 6 = Running (Slow Start) 7 = Running (Prestop) 8 = Running (Full Flow)	R	I
45	Relay State	0 to 15 Binary representation of relay state. 0 = open; 1 = closed. B0 = relay 1 (LSB) B1 = relay 2 B2 = relay 3 B3 = relay 4	R	I
46	Relay Control	0 to 15 Binary representation of relay control. 0 = open; 1 = close. Note: Only the general relays configurable in the Alarm section of calibration are able to be viewed and controlled by Modbus. B0 = relay 1 (LSB) B1 = relay 2 B2 = relay 3 B3 = relay 4	R/W	I

Register	Name	Comments	Read Only or Read/Write	Type
47	Relay Control Source	0 to 15 Binary representation of relay control source. 0 = Local (controlled by instrument operation) 1 = RTU (controlled by Modbus register 46). B0 = relay 1 (LSB) B1 = relay 2 B2 = relay 3 B3 = relay 4	R/W	I
48	Reserved			
50	Control Mode	0 = Idle/Local Control from logic inputs 1 = Stop Suspend current batch 2 = Run Resume/start batch 3 = Reset Clear current batch totals	R/W	I
51 to 99		This bank of registers gives access to the control set point values in the same order as described within Parameters on page 35. The accessible values are those items immediately following the parameter items that sets the access as either USER or RTU.	R if 42 = 0 R/W if 42 = 1	FP [†]
101	Analog Inp.1	Raw analog input data.	R	FP
103	Analog Inp.2	4-20mA inputs are read in Amperes.	R	FP
105	Analog Inp.3	0-5V or 1-5V inputs are read in Volts RTD inputs are read in degrees Kelvin.	R	FP
107	Analog Inp.4	Unused inputs are configured as 4-20mA.	R	FP

* I = Integer (2 bytes) (Holding Registers)

† FP = Floating Point (2 register = 4 bytes)

Printer Protocol

A printer protocol is available in the 500 Series. It provides the ability to print out live data, individual logged data and to do some report-style printing of logged data. The method of printing these and the format of the printouts is described below.

Note: Printer output is only available if the Real Time Clock option is fitted and is only available on the RS232 communications port.

The selection of Printer Protocol can be made for the Communications Protocol options for the RS232 port. A list of log report types and printer types available at the end of the TM-LOG calibration menu.

Report Types

The list of report types is as follows:

- REP-10 Latest Logs Report

The number of logs printed in each report are determined by the values programmed for Report Logs in the TM-LOG menu.

Printer Types

The list of available printers is as follows:

- PRN-01 Generic computer printer
- PRN-02 Generic roll printer (printing first line first)
- PRN-03 Slip Printer TM295

Customizing a Printout

A customized printout can be provided which can have up to 4 header lines and 3 footer lines. It is also possible to include or exclude each main menu items on the printout. If any customizing of the printout is required discuss this with the distributor.

Types of Printouts

Live Data

The RESET key, when in main menu, is shared as the PRINT key if the printer protocol has been selected. A printout will be initiated whenever this key is pressed. If printing is not required, do not select printer protocol.

The format of this printout will be:

Custom Header Line 1
Custom Header Line 2
Custom Header Line 3
Custom Header Line 4

Current Docket No.

Instrument Serial No. & Tag

Current Date & Time & Status

Variable unit value

Variable unit value

Variable unit value

etc.

Custom Footer Line 1

Custom Footer Line 2

Custom Footer Line 3

----- <separation line>

(Note that blank header and footer lines are not printed).

Docket Number

The docket number that appears on the live data printout indicates the print number. This number is cleared when the Accumulated totals are reset. If the Reset Mode is set for Delayed, where a print can be generated without resetting the non-accumulated totals, an additional number in brackets will be shown that indicates the number of prints since the last reset. i.e.

DOCKET No. 000256 (000036)

Instrument Serial Number and Unit Tag

The instrument serial number and unit tag is the same as the information shown in the Model Info menu. For more details refer to [Model Information](#) on page 20

Individual Log Data

When in the Log Menu and while holding the DISPLAY key to view the data of the log of interest the RESET key can be pressed to initiate a printout of that log entry. The printout will have the time and date stamp corresponding to when the log was taken. After the print has been initiated there will be the opportunity to scroll to view another log entry and print again.

Since each log entry stores the delivery totals only, the printout will not have any accumulated totals. The format of the printout with this exception is the same as the LIVE DATA printout:

*Custom Header Lines**Instrument Serial No. & Tag**Delivery No. Date & Time & Status**Variable unit value**Variable unit value**Variable unit value**etc.**Custom Footer Lines*

----- <separation line>

Log Report Printing

As there is the likelihood that the reports can be of a considerable length it is strongly recommended that only the 80 Column printer with Z fold (tractor feed) paper be used. This is just as much for the memory storage of printer as it is for the reliable paper supply.

There is a HOLD.SET REPORT PRINT prompt under the main menu with the ability to print the pre-selected type of report. Pressing and holding the SET key for two seconds will initiate the printout. Any of the Log Reports will have the following format:

*Custom Header Lines**Title of Report*

<internally set, indicates report type>

*Current Date & Time**Instrument Serial No. & Tag*

----- <separation line>

*Delivery No. Date & Time & Status**Variable unit value**Variable unit value**Variable unit value**etc.*

----- <separation line>

*Delivery No. Date & Time & Status**Variable unit value**Variable unit value**Variable unit value**etc.*

----- <separation line>

Delivery No. Date & Time & Status

Variable unit value

Variable unit value

Variable unit value

ETC

Custom Footer Lines

----- <separation line>

Reports such as “Latest Logs” will print in the historical order, and for those logs that have no data (e.g. unit was powered off at the time) the print will show “Data not available”. i.e.

----- <separation line>

Del No. Data Not Available

----- <separation line>

Delivery No. Date & Time & Status

Variable unit value

Variable unit value

Variable unit value

etc.

If the unit is programmed for 0 logs for the latest log reports then the report will only consist of the header and ID information and a “Data Not Available” message.

Custom Header Lines

Title of Report

Current Date & Time

Instrument Serial No. & Tag

Data Not Available

Custom Footer Lines

----- <separation line>

Printer Data Control

Some printers have limited data buffers and are therefore unable to collect all the print data being transmitted. The 500 Series has the capability of software handshaking. The Xon/Xoff characters can be used by any of the printer types to control the flow of data to ensure that data is not lost.

Some printers will also transmit an Xoff character in response to other events such as printer being off-line, print head not engaged or power being removed. The specific behaviour of the printer being used should be noted.

Error Messages

There are two printer error messages that can be displayed.

PAPER OUT

This message is related to the Printer Type PRN-03 TM295 Slip printer. It is standard procedure with this printer to check for paper status before printing. If a print is attempted but there is no paper the PAPER OUT message will be scrolled. The instrument will continue to poll the printer for paper and if paper is detected before a communications timeout expires the print will commence.

COMMS TIMEOUT

This message is relevant for all printer types and will be activated for the following conditions.

1. If the flow of data is stopped due to software or hardware handshaking and is not allowed to resume before the communications timeout.
2. If Printer Type is PRN-03 Slip printer and a paper status is requested but no response is received within the timeout period.
3. Paper Out has been detected for Printer Type PRN-03 but no paper is inserted within the timeout period.

When a communications timeout error has been activated the message COMMS TIMEOUT will be scrolled once, the request to print will be cleared and the instrument will return to its normal mode.

Appendix A

Glossary

ASCII	American Standard Code for Information Interchange. For the ASCII protocol, the instrument receives and transmits messages in ASCII, with all command strings to the instrument terminated by a carriage return. Replies from the instrument are terminated with a line-feed and a carriage-return.
Filtering	The process of suppressing oscillations or random signals in the input signal.
IrDA	The Infra-red Developers Association is a group of computer and software manufacturers who have agreed on a format for communication among infrared devices.
K-factor	The K-factor is a constant value associated with frequency type flowmeters. It is a scaling factor used in calculations to determine volumetric flow rate.
Linear Correction	A scaling of the input signal to represent the actual flow parameter.
Modbus RTU	The Modbus protocol is a message structure for communications between controllers and devices regardless of the type of network. In RTU (remote terminal unit) mode, each 8-bit byte in a message contains two 4-bit hexadecimal characters. This mode has greater character density than ASCII and allows better data throughput than ASCII for the same baud rate.
Normalised Input	A normalised input ranges from 0 to 1.000. For 4-20mA input, the signal is set to 0 at 4mA and the signal is set to 1.000 at 20mA.
NPS	Namur Proximity Switch.
Passive Output Signal	Requires an external power supply.

Appendix B

Model Numbers

Product Codes

Model	Supplementary Code		Description
515	- BF03		
Enclosure	1		Panel mount enclosure
	2		Field mount enclosure (not yet available)
	3/5		Explosion proof Ex410 with metric glands (5 specifies heater version)
	4/6		Explosion proof Ex410 with NPT glands (6 specifies heater version)
Output Options	0		Basic – 9 way DB RS232 serial port, 2 relays, 1 isolated 4-20 or pulse output and 4 logic inputs
	1		Advanced - also includes RS485 port, 2 extra relays, 1 extra isolated output and Real-time clock for printer output and logging
CPU Type	0		Original - no ASCII or printer protocol, basic logging (100 logs)
	1		Standard - ASCII and printer protocol, extra logging (1000+ logs)
Power Supply	E		For 220/240 VAC
	A		For 110/120VAC
	D		For DC power only 12-28VDC
Display Panel Options		F	Fully optioned (with backlight, LCD backup and Infra-Red comms port)
PCB Protection	C		Conformal coating - required for maximum environmental operating range. Recommended to avoid damage from moisture and corrosion.
	N		None - suitable for IEC standard 654-1 Climatic Conditions up to Class B2 (Heated and/or cooled enclosed locations)
Application Pack Number		BF03	Defines the application software to be loaded into the instrument
For example: Model No. 515.111EFC Displayed on the 500 Series as: (only h/w that affects the operation is represented)			- 11-F - 515 MODEL

Note: Example full product part number is 515.111EFC-BF03 (This is the number used for placing orders).

Custom Version Codes

	Code		Description
Origin Code Identifies Distributor	00		Factory Default Application
	01		Contrec Pty. Ltd. Melbourne Australia
	02		Contrec Pty. Ltd. Sydney Australia
	03		Contrec Europe Ltd. West Yorkshire UK
	04		Contrec - USA, LLC. Pelham AL 35124 USA
	05		Flowquip Ltd. Halifax UK
	06		
	etc.		
User Language	0		English (Default)
	1		German
	2		Dutch
	3		French
	4		Spanish
	5		
	etc.		
Distributor's Code	000		Distributor's own choice. Possibly a code that identifies the customer and the application.
	...		
	999		
For example: 02 3 157 Displayed on the 500 Series as:			023 157 CUSTOM VERS

Application Information Code

The Application Information code is an aid for users and service personnel to determine the type of inputs that are used in a particular application. The Application Information code is displayed on the instrument as shown below.

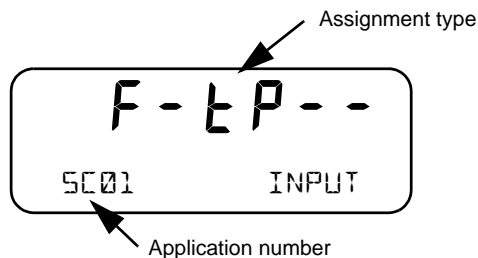

The Application Information code is returned as part of a General Instrument request (as described in [Instrument Information Request](#) on page 60).

The Application number identifies the application as in the following examples:

- SC01 - steam flow computer for frequency flow meter
- GN02 - natural gas flow computer for analog flow meter

The Input Assignment type indicates the physical input that is assigned to each input on the instrument. The code is made up from six characters as follows:

FINP1	FINP2	AINP1	AINP2	AINP3	AINP4
X	X	X	X	X	X

The codes are as follows:

- - - not used in this application
- *A* - indicates a generic analog input such as for density or level
- *d* - indicates a density input
- *F* - indicates a generic flow input such as for volume or mass, (frequency or analog)
- *H* - indicates a high flow input for stacked inputs
- *L* - indicates a low flow input for stacked inputs
- *P* - indicates a pressure input
- *Q* - indicates a quadrature input
- *t* - indicates a temperature input.

For example, *F - t P - -* is an instrument with FINP1 (frequency input 1) assigned to a flow input, AINP1 assigned to a temperature input and AINP2 assigned as a pressure input. The other inputs are not used.

Appendix C

Units of Measurement

Available Units of Measurement

The following is a list of the available units of measurement used across the range of 500 Series applications.

Units Type	Available units of measurement
Volume	m ³ , Km ³ , Ltr, Gal, KGal, MGal, ft ³ , kft ³ , Mft ³ , bbl
Volume Flowrate	m ³ /s, m ³ /min, m ³ /h, m ³ /D, L/s, L/min, L/h, Gal/s, Gal/min, Gal/h, KGal/D, MGal/D, ft ³ /s, ft ³ /min, ft ³ /h, Mft ³ /D, bbl/s, bbl/min, bbl/h, bbl/D
Volume K-Factor	P/m ³ , P/Ltr, P/Gal, P/ft ³ , P/bbl
Mass	kg, g, Ton, lb, Klb
Mass Flowrate	kg/s, kg/min, kg/h, g/s, g/min, g/h, Ton/min, Ton/h, Ton/D, lb/s, lb/min, lb/h, Klb/min, Klb/h, Klb/D
Mass K-Factor	P/kg, P/g, P/Ton, P/lb, P/Klb
Energy	kJ, MJ, GJ, kWh, MWh, kBTU, Ton.h, therm, cal, kcal, Mcal
Power	kJ/h, MJ/h, GJ/h, kW, MW, kBT/M, kBT/h, Ton, therm/min, therm/h, kcal/h, Mcal/h
Energy K-Factor	P/kJ, P/kWh, P/kBTU, P/Ton.h, P/therm, P/kcal
Temperature	Deg K, Deg C, Deg F, Deg R
Pressure	Pa, kg/m ² , kg/cm ² , kPa, MPa, mbar, bar, psi, Atm, inH ₂ O, mmH ₂ O
Density	kg/m ³ , kg/Ltr, lb/ft ³ , SG60F
Specific Volume	m ³ /kg, L/kg, ft ³ /lb
Specific Enthalpy	kJ/kg, BT/lb, cal/g, cal/kg, kcal/kg, Mcal/kg
Reynolds Number	E+0, E+3, E+6 (scaling for unitless variable)
Length (Level)	m, mm, cm, INCH, FOOT
Velocity	m/s, m/M, m/h,ft/s, ft/M, ft/h
Length K-Factor	P/m, P/cm, P/INCH, P/FOOT
Area	m ² , ft ²
Ratio	%

Index

Numerics

4-20mA
output 10

A

address, instrument 56
alarm
delay 45
equipment failure 44
hysteresis 45
relays 44
setpoint 44
alarms menu 44
application code 76
approvals 4
ASCII protocol 55

B

back panel 8
batch
configurations 24
errors 26
operations 27
start 25
stop 25, 26
batch control 24
BATCH key 16
batch limit 17
batch modes 23
batch preset
common values 17
batch processes 27
battery
failed 52
life 47
new 52
baud rate 46

C
calibration
menu 32
set mode 30
view mode 29

clock

battery 47
date format 48
real-time 47

codes

application information 76
customer version 76
exception 64
product number 75

common preset values 17

communication

connections 13
protocols 55

communications 3, 53

menu 45

connections

communication 53
communications 13
control relays 11
electrical 8
input 9
output 10

control loop

tuning 21

control modes 20

customer version codes 76

customizing a printout 67

D

data log

viewing 18

date format 48

default variable 15

delay, alarm 45

digital output 11

display

specifications 5
timeout mode 49
timeout time 49

DISPLAY key 16

display-only parameter 29

E

earthing 14
edit batch preset 17
electrical connections 8
equipment failure alarm 44
error messages 52
exception codes 64
Exception Status 57

F

features 1
flash driver port assignment 47
flow control
 local 20
 loop 21
 tune 21
format, date 48
frequency input connection 9
front panel 15
 infra-red port 13
 keys 16
 lamps 16

G

general specifications 5
glossary 73

H

hardware connections 53
hysteresis, alarm 45

I

infra-red port 13, 45, 54
input
 connections 9
 frequency 9
 specifications 5
inputs menu 39
installation 7
instrument
 address 56
 request format 56
 responses 57
 settings 34
interconnections, communication 53
interference suppression 12
isolated outputs 3

K

key
 BATCH 16
 DISPLAY 16
 RESET 16
 RUN 16
 SET 17
 STOP 16
 TOTAL 16
keys, front panel 16

L

lamps, status 16
local flow control 20
logged data 18
 viewing 18
logic input connection 10
logic input control 26
loop flow control 21

M

main menu items 16
menu
 alarms 44
 calibration 32
 comms 45
 inputs 39
 outputs 42
 params 35
 setup 49
 test 50
 tm/log 47
 units 34
messages
 error 52
 system 51
 warning 52
Modbus RTU protocol 61
mode
 display timeout 49
 process control 20
 set calibration 30
 view calibration 29
model numbers 75
modes, batch control 23
mounting 7

N

number

- model 75
- serial 20

O

on-off mode 23

operation configurations 24

operation, batch control 24

operation, control modes 20

operation, front panel 15

output

- connections 10
 - 4-20mA 10
 - digital 11
- pulse factor 43
- specifications 5

outputs menu 42

P

panel

- lamps 16
- mounting 7
- rear 8

parameter

- display-only 29
- not visible 29
- password-protected 29
- programmable 29

parameters menu 35

parity bits 46

password-protected parameter 29

port

- assignment, flash driver 47
- flash driver assignment 47
- infra-red 13, 45, 54
- RS-232 13, 45, 53
- RS-485 13, 45, 54

power supply interruption 47

preset batch value 17

preset mode 23

printer

- data control 70
- error messages 71
- protocol 67
- report types 67

printer types 67

printouts

- individual logs 68
- live data 67
- log report 69
- types 67

product number codes 75

programmable parameters 29

protocol

- ASCII 55
- communication 55
- Modbus RTU 61
- printer 67

pulse factor, output 43

R

real-time clock 47

rear panel 8

relay

- connection 11

relay outputs 3

relays, alarm 44

release mode 23

remote control 26

RESET key 16

responses, instrument 57

RS-232 port 13, 45, 53

RS-485 port 13, 45, 54

RTU protocol 61

RUN key 16

S

serial number 20

SET key 17

setpoint, alarm 44

settings

- instrument 34

setup menu 49

shielding 14

snubber 12

specifications 5

standards 4

starting a batch 25

status lamps 16

stop bits 46

STOP key 16

stopping a batch 25, 26

suppression, interference 12

system

- errors 52
- messages 51
- warnings 52

T

- terminal designations 8
- test menu 50
- timeout
 - mode 49
 - time 49
- tm/log menu 47
- TOTAL key 16
- tune mode 21
- tuning control loop 21

U

- unit tag 20
- units
 - menu 34

V

- variable, default 15
- version, customer 76
- view data logs 18

W

- warnings 52